

ASPLUND | COLLECTION



MADE IN SWEDEN

Our storage and furniture collection are produced in Sweden. This means that we can guarantee that production takes place under both ethically and environmentally sustainable conditions. We see it as our responsibility as a producer to make furniture that will last for generations.

Our belief is that items made of the highest quality, have high aesthetic quality, and are made with sustainable methods, will always live longer.

The products in our collection are designed together with Swedish and international designers such as; Broberg & Ridderstråle, Thomas Sandell, Jonas Bohlin, Piero Lissoni, Tom Dixon, Claesson Koivisto Rune, Anya Sebton, Eva Lilja Löwenhielm and many more that have the same values regarding design and quality as us.



Index

Storage

- Snow Series _____ P. 6
- Kilt Open _____ P. 8
- Kilt Sideboard _____ P. 10
- Kilt Light _____ P. 12
- Luc Series _____ P. 14
- Luc Deluxe _____ P. 16
- Luc Console _____ P. 18
- Vass Series _____ P. 20
- Frame Serie _____ P. 22
- Frame XL _____ P. 24
- Frame TV/Media _____ P. 26
- Frame Cabinet _____ P. 28
- Frame Semi Cabinet _____ P. 28
- Besson _____ P. 30
- Xi Cabinet _____ P. 32

Furniture

- Palais Series _____ P. 36-39
- Pagoda Series _____ P. 40
- Oblique Sliding Table _____ P. 42
- Oblique Coffee Table _____ P. 44
- Oblique Desk/ Sidetable _____ P. 44
- Bermuda _____ P. 46
- Tati _____ P. 48
- Tati Series _____ P. 50
- Tati Desk _____ P. 52
- Tati Night Table _____ P. 52
- Plectra Series _____ P. 54

Small furniture

- Air _____ P. 56
- Belle Petit & Belle _____ P. 58
- Tati Mirror _____ P. 60
- Otto _____ P. 62
- Tati Coat Rack _____ P. 64

STORAGE

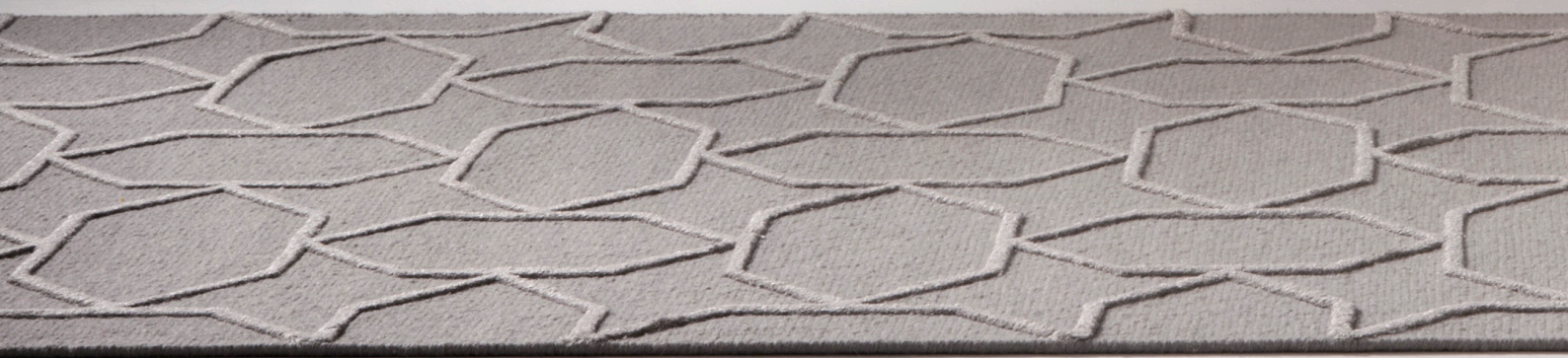



SNOW SERIES

By Thomas Sandell & Jonas Bohlin 1994

Storage in lacquered MDF with base in birch. The drawers are soft-closing.
Manufactured in Sweden.

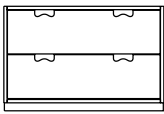

Snow Drawer A2

H: 59 cm
D: 42 cm
W: 90 cm

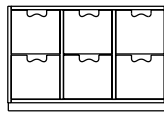

Snow Drawer B2

H: 59 cm
D: 42 cm
W: 90 cm

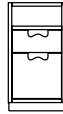

Snow Drawer G3

H: 59 cm
D: 42 cm
W: 31,1 cm
Extra castors can be ordered.

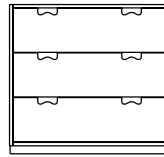

Snow Drawer A3

H: 84 cm
D: 42 cm
W: 90 cm

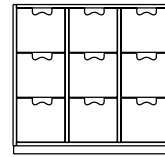

Snow Drawer B3

H: 84 cm
D: 42 cm
W: 90 cm

Colours:

- 05 Light Grey
- 15 White
- 25 Rose
- 40 Storm Grey
- 44 Nordic Blue
- 45 Green Khaki
- 46 Dark Sand
- 47 Taupe
- 49 Char Grey

Standard base:
Natural Birch

Additional:

- Optional Base:
Lacquered base
P1- Natural Oak
P2 - White Stained Oak
P4 - Black Walnut Oak
P6- Dark Smoked Oak

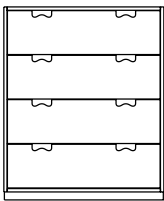

Snow Drawer A

H: 109 cm
D: 42 cm
W: 90 cm

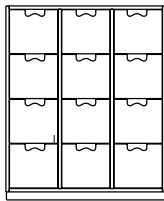

Snow Drawer B

H: 109 cm
D: 42 cm
W: 90 cm

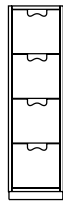

Snow Drawer J4

H: 109 cm
D: 42 cm
W: 31,3 cm



Temporarily unavailable
Snow Drawer J8

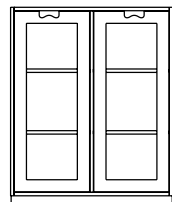

Snow Cabinet E (Glass doors)

H: 109 cm
D: 30 cm alt. 42 cm
W: 90 cm

Cabinet with glass doors with middle partition and four shelves, choose between two depths. Extra shelves can be ordered.

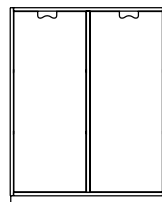

Snow Cabinet E (Covered doors)

H: 109 cm
D: 30 cm alt. 42 cm
W: 90 cm

Cabinet with glass doors with middle partition and four shelves, choose between two depths. Extra shelves can be ordered.

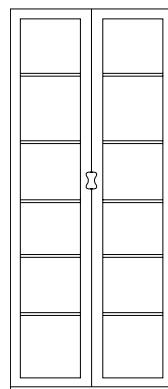

Snow Cabinet F (Glass Doors)

H: 210 cm
D: 30 cm alt. 42 cm
W: 90 cm

Cabinet with glass doors and lacquered shelves, choose between two depths. Extra shelves can be ordered.

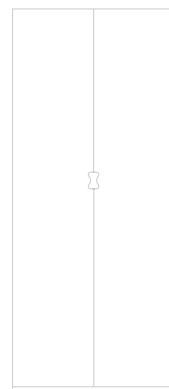

Snow Cabinet F (Covered doors)
Temporarily unavailable

ASPLUND

Fotograf: Louise Billgert

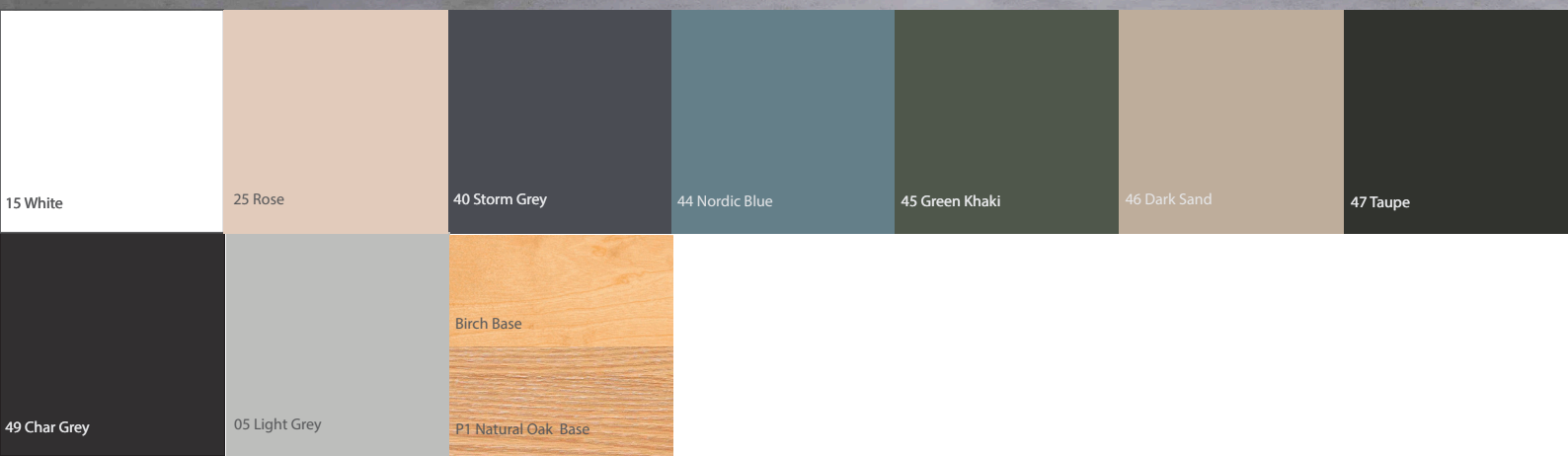

KILT OPEN

By Claesson Koivisto Rune 2010

Veneer:

P1 - Natural Oak

P2 - White Stained Oak

P4 - Black Walnut Oak

P6 - Dark Smoked Oak

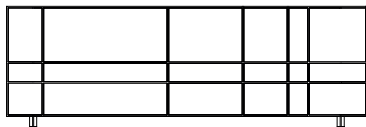

Kilt Open 180

H: 60 cm (runners 5 cm)

D: 29,5 or 43,5 cm

W: 180 cm

Open storage in oak veneer with fixed interior.

Choose between P1, P2, P4 and P6.

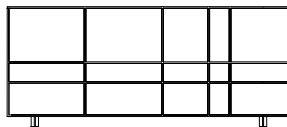

Kilt Open 137

H: 60 cm (runners 5 cm)

D: 29,5 or 43,5 cm

W: 137 cm

Open storage in oak veneer with fixed interior.

Choose between P1, P2, P4 and P6.

ASPLUND

Fotograf: Louise Billgert



P1 Natural Oak Base

P2 White Stained Oak

P4 Black Walnut Oak

P6 Dark Smoked Oak

KILT SIDEBOARD

By Claesson Koivisto Rune 2008

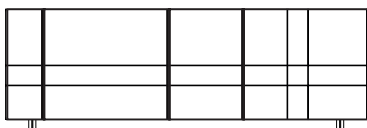

Kilt Sideboard 180
(doors)

H: 60 cm (runners 5 cm)
D: 31,5 cm alt 45 cm
W: 180 cm

Cabinet with four doors with one removable shelf behind each door. Door measurement from left: 18/62/37/62 cm.

Lacquered MDF or Veneer P4, P6.
Runners in oak

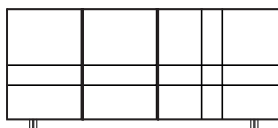

Kilt Sideboard 137
(doors)

H: 60 cm (runners 5 cm)
D: 31,5 cm alt 45 cm
W: 137 cm

Cabinet with three doors with one removable shelf behind each door.

Lacquered MDF or Veneer P4, P6.
Runners in oak

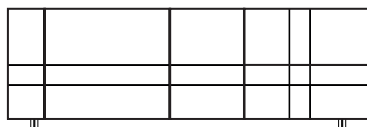

Kilt Sideboard 180
(doors & drawers)

H: 60 cm (runners 5 cm)
D: 31,5 cm alt 45 cm
W: 180 cm

Cabinets with three doors and two drawers (62 cm, to the right).
Door measurement from left: 18/62/37 cm + drawers.
One removable shelf behind each door.

Lacquered MDF or Veneer P4, P6.
Runners in oak
Inside of drawers in birch.
Addition for oak drawers

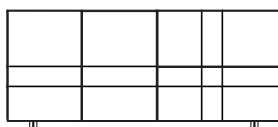

Kilt Sideboard 137
(doors & drawers)

H: 60 cm (runners 5 cm)
D: 31,5 cm alt 45 cm
W: 137 cm

Cabinet with two doors and two drawers to the right, comes with one removable shelf behind each door.

Lacquered MDF or Veneer P4, P6.
Runners in oak
Inside of drawers in birch.
Addition for oak drawers

Colours:

15 White
30 Deep Blue
40 Storm Grey
44 Nordic Blue
45 Green Khaki
46 Dark Sand
47 Taupe
49 Char Grey

Veneer:

P4 - Black Walnut Oak
P6 - Dark Smoked Oak

Runners in solid oak:

P1 - Natural Oak
P2 - White Stained Oak
P4 - Black Walnut Oak
P6 - Dark Smoked Oak

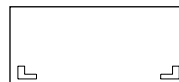

Standard back for Kilt:
Openings on the back for cables/ventilation.

ASPLUND

Fotograf: Louise Billgert



15 White	30 Deep Blue	40 Storm Grey	44 Nordic Blue	45 Green Khaki
46 Dark Sand	47 Taupe	49 Char Grey	P1 Natural Oak Base	P2 White Stained Oak
				P4 Black Walnut Oak
				P6 Dark Smoked Oak

KILT LIGHT

By Claesson Koivisto Rune 2011

Storage series in lacquered MDF with a lacquered metal stand. Inside of drawer in birch.

Colours:

- 15 White
- 30 Deep Blue
- 40 Storm Grey
- 44 Nordic Blue
- 45 Green Khaki
- 46 Dark Sand
- 47 Taupe
- 49 Char Grey

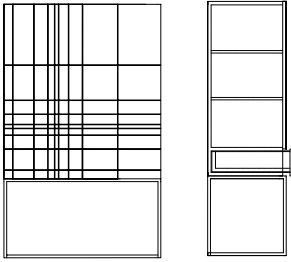

Kilt Light 90

H: 145 cm (stand 45 cm)
D: 45 cm
W: 90 cm

Cabinet in lacquered MDF with lacquered metal stand in the same colour. Two drawers and two doors.

Addition for oak inside drawers

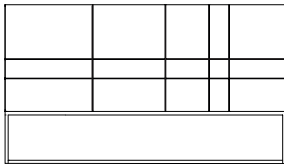

Kilt Light 137

H: 87 cm (stand 32 cm)
D: 45 cm
W: 137 cm

Cabinet in lacquered MDF with lacquered metal stand in the same colour. One shelf included behind each door.

Cabinet with three doors (D)

Cabinet with two doors and two drawers to the right (DB)

Addition for oak inside drawers

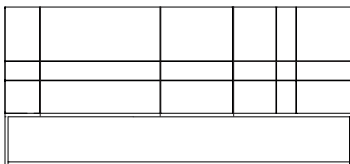

Kilt Light 180

H: 87 cm (stand 32 cm)
D: 45 cm
W: 180 cm

Cabinet in lacquered MDF with lacquered metal stand in the same colour. One shelf included behind each door. Door measurement from left: 18/62/37/62 cm

Cabinet with four doors (D)

Cabinet with three doors and two drawers to the right (DB)

Addition for oak inside drawers



Standard back for Kilt light:
Openings on the back for cables/ventilation.

ASPLUND

Fotograf: Louise Billgert

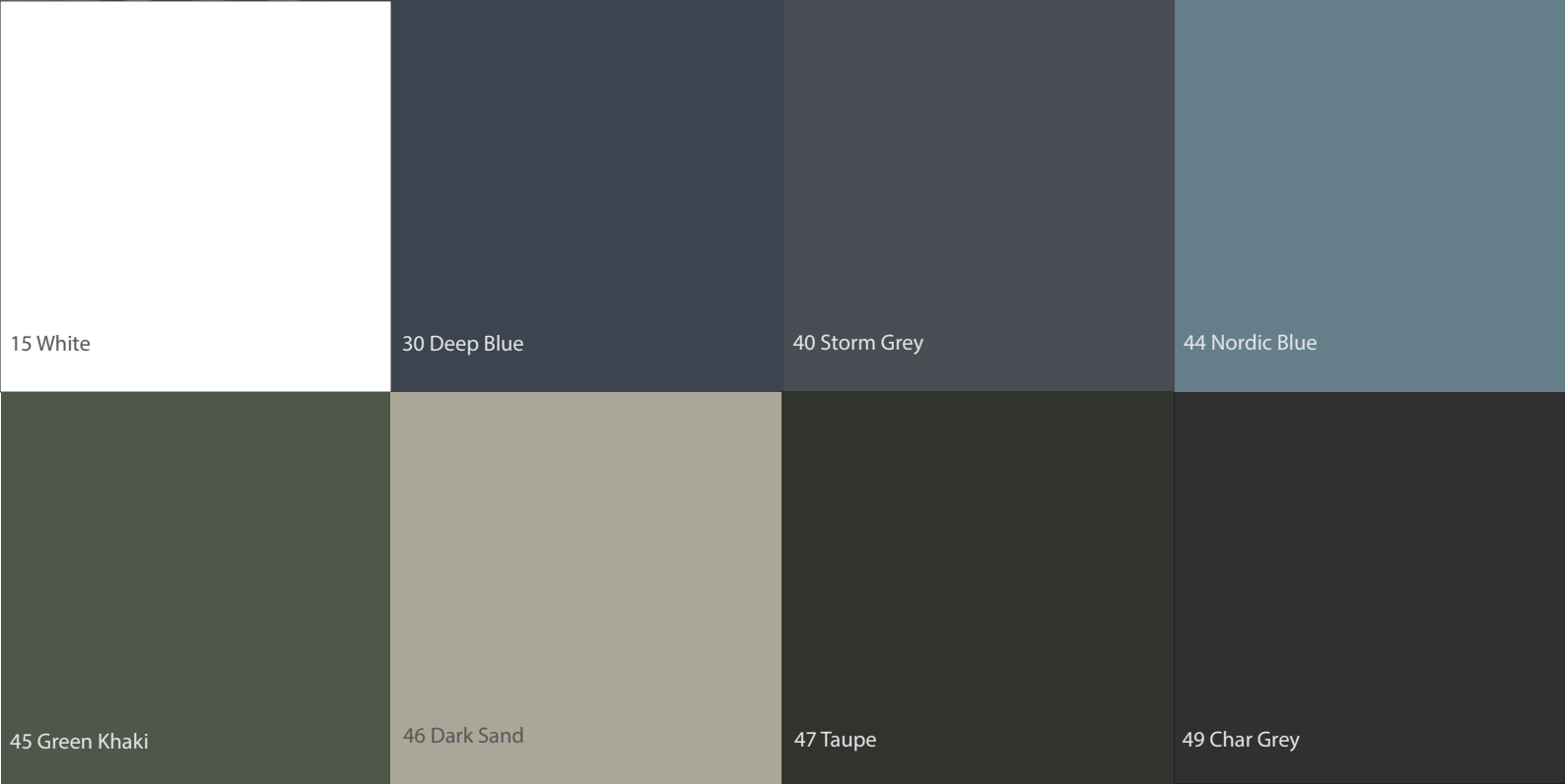

LUC SERIES

By Broberg & Ridderstråle 2012

Storage units in oak veneer with metal stand and stone or glass top

Cabinet in veneer:

P1 - Natural Oak
 P2 - White stained Oak
 P4 - Black walnut Oak
 P5 - Char Lacquered Oak
 P6 - Dark Smoked Oak

Top:

Carrara marble
 Belgian limestone
 Nuvolato marble
 Jura Grey Limestone
 Glass*

Stand in lacquered metal:

15 White
 30 Deep Blue
 40 Storm Grey
 44 Nordic Blue
 45 Green Khaki
 47 Taupe
 49 Char Grey

*Note that the cabinet with glass top has a fixed shelf

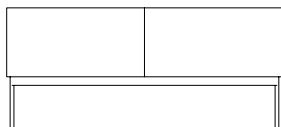

Luc Sideboard 160 (drawers)

H: 70 cm (stand 30 cm)
 D: 42 cm
 W: 160 cm

Storage with 2 drawers in oak veneer with a lacquered stand and a stone or glass top.

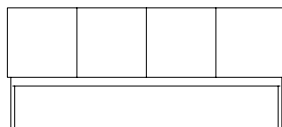

Luc Sideboard 160 (doors)

H: 70 cm (stand 30 cm)
 D: 42 cm
 W: 160 cm

Storage with a stand in lacquered metal and stone or glass top. Cabinet with two compartments and four doors. Including one lacquered shelf.

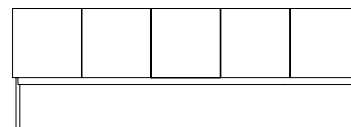

Luc Sideboard 200 (doors)

H: 70 cm (stand 30 cm)
 D: 42 cm
 W: 200 cm

Storage with 5 doors in carefully chosen oak veneer. Stand in lacquered metal.



Luc Drawer 100 (Temporarily unavailable)

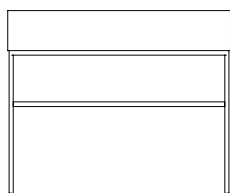

Luc Console 100 Oak

H: 81 cm
 D: 40,4 cm
 W: 99 cm

Sideboard in oak veneer (P2, P4, P5 or P6) with one drawer and a lacquered MDF shelf. Stand in lacquered metal.

Top in stone. Hidden grip.

Choose between:

1. Cabinet in: P1, P2, P4, P6 or P5 Char Grey
2. Top: Carrara Marble, Nuvolato Marble, Jury Grey Limestone or Belgian Limestone
3. Stand: 15 White, 30 Deep Blue, 40 Storm Grey, 44 Nordic Blue, 45 Green Khaki, 47 Taupe or 49 Char Grey.

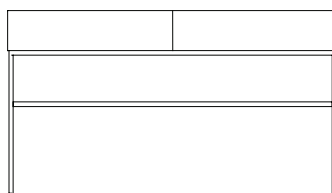

Luc Console 160 Oak

H: 81 cm
 D: 40,4 cm
 W: 158,4 cm

Sideboard in oak veneer (P2, P4, P5 or P6) with one drawer and a lacquered MDF shelf. Stand in lacquered metal.

Top in stone. Hidden grip.

Choose between:

1. Cabinet in: P1, P2, P4, P6 or P5 Char Grey
2. Top: Carrara Marble, Nuvolato Marble, Jury Grey Limestone or Belgian Limestone
3. Stand: 15 White, 30 Deep Blue, 40 Storm Grey, 44 Nordic Blue, 45 Green Khaki, 47 Taupe or 49 Char Grey.

ASPLUND

Fotograf: Louise Billigert



LUC DELUXE

By Broberg & Ridderstråle 2012

Cabinet in lacquered oak veneer with stone top and wooden stand.

Colours in P5:

40 Storm grey
44 Nordic Blue
46 Dark Sand
47 Taupe
49 Char Grey

Top:

Carrara marble
Belgian limestone
Nuvolato marble
Jura Grey Limestone

Stand in massive oak:

P1 - Natural Oak
P2 - White stained Oak
P4 - Black walnut Oak
P6 - Dark Smoked Oak

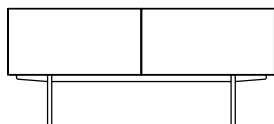

Luc Deluxe 160 (drawers)

H: 70 cm (stand 30 cm)
D: 42 cm
W: 160 cm

Storage in lacquered oak veneer with a wooden base and stone top.

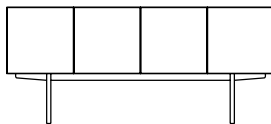

Luc Deluxe 160 (doors)

H: 70 cm (stand 30 cm)
D: 42 cm
W: 160 cm

Storage in lacquered oak veneer with a wooden base and stone top. Cabinet with two compartments and four doors.

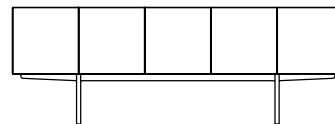

Luc Deluxe 200 (doors)

H: 70 cm (stand 30 cm)
D: 42 cm
W: 200 cm

Storage with 5 doors in lacquered oak veneer with a wooden base and stone top.

ASPLUND

Fotograf: Louise Billgert



LUC CONSOLE

By Broberg & Ridderstråle 2015

Lacquered Console with brass knob and stone or wood top

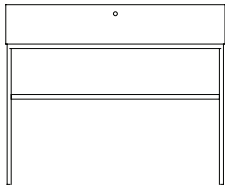

Luc Console 100

H: 81 cm
D: 40,4 cm
W: 99 cm

Console in lacquered MDF with one drawer with a brass knob and a lacquered MDF shelf. Stand in lacquered metal. Top in stone or oak veneer.

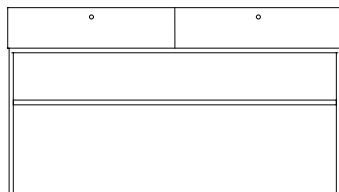

Luc Console 160

H: 81 cm
D: 40,4 cm
W: 158,4 cm

Sideboard in lacquered MDF with 2 drawers with brass knobs and a lacquered MDF self. Stand in lacquered metal. Top in stone or oak veneer.

Luc Console in oak, see Luc series page 14.

Colours:

15 White
40 Storm grey
44 Nordic Blue
45 Green Khaki
47 Taupe
49 Char Grey

Top:

Carrara marble
Belgian limestone
Nuvolato marble
Jury Grey Limestone
P1 - Natural Oak
P2 - White Stained Oak
P4 - Black Walnut Oak
P6 - Dark Smoked Oak

Stand:

15 White
30 Deep Blue
40 Storm grey
44 Nordic Blue
45 Green Khaki
47 Taupe
49 Char Grey

ASPLUND

Fotograf: Louise Billgert

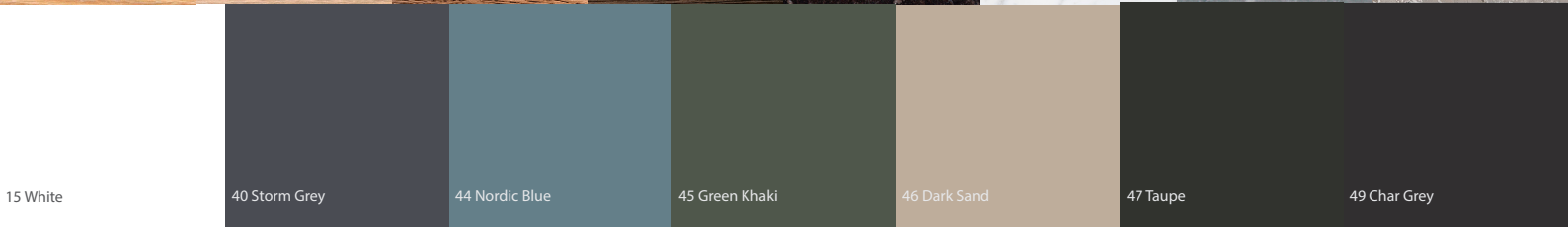
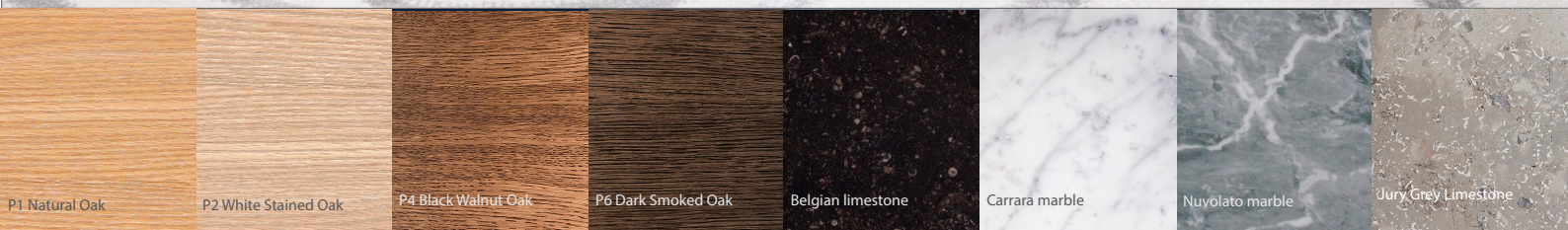

VASS SERIES

By Claesson Koivisto Rune 2007

Storage series in lacquered MDF or oak veneer. Stand in solid oak. Please note that floor protection feet will add about 0,5 cm to the height. Manufactured in Sweden.



(temporarily unavailable)
Vass 40:90 Wall
2 doors



(temporarily unavailable)
V40:135 Wall
3 doors



Vass 40:90 Stand (temporarily unavailable)
2 doors

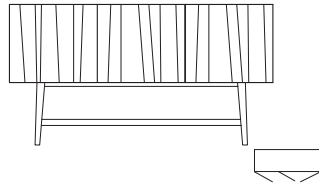

Vass 40:135 Stand
3 doors
H: 72 cm (stand 32 cm)
D: 40 cm
W: 135 cm

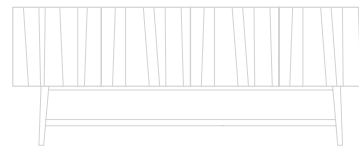

(temporarily unavailable)
Vass 40:180 Stand
4 doors. 2 sections

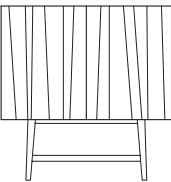

Vass 60:90 Stand
2 doors
H: 92 cm (stand 32 cm)
D: 40 cm
W: 90 cm

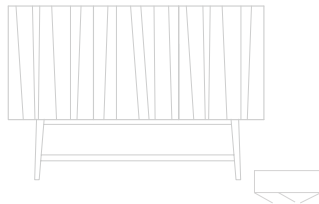

(temporarily unavailable)
Vass 60:135 Stand
3 doors

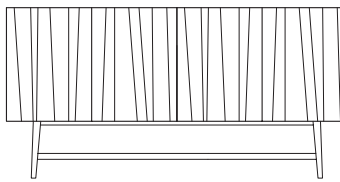

Vass 60:180 Stand
4 doors. 2 sections
H: 92 cm (stand 32 cm)
D: 40 cm
W: 180 cm

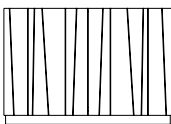

Vass 60:90 Base
2 doors
H: 65 cm
D: 40 cm
W: 90 cm

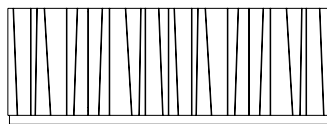

Vass 60:180 Base
4 doors. 2 Sections
H: 65 cm
D: 40 cm
W: 180 cm

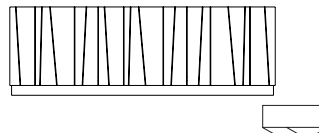

Vass 40:135 Base
3 doors
H: 65 cm
D: 40 cm
W: 135 cm



Standard back:
Openings on the back for cables/ventilation.

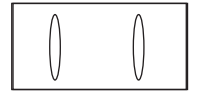

Standard back for Vass Wall mounted:
Bigger openings for cables/ventilation.

Colours:
15 White
40 Storm Grey
45 Green Khaki
46 Dark Sand
P4 - Black Walnut Oak
P6 - Dark Smoked Oak

Stand in sold oak:
P1 - Natural Oak
P2 - White Stained Oak
P4 - Black Walnut Oak
P6 - Dark Smoked Oak
Height stand: 32 cm

A removable shelf behind each door is included.

Additional options:
Wooden base is available to all Vass storage. Base 5 cm.

Choose oak veneer:
P4 - Black Walnut Oak
P6 - Dark Smoked Oak

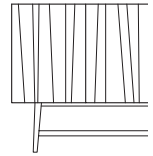

Stand

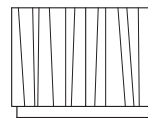

Base

ASPLUND

Fotograf: Louise Billoger



FRAME SERIES

By Anya Sebton & Eva Lilja Löwenhielm 2014

Storage with covered folding doors or drawers with handles in leather.

Material: Lacquered MDF

Standard: Hinges on the left hand side.

Cable holes in the backside.

The ones with glass doors have no holes in the back.

Colours:

- 05 Light Grey
- 15 White
- 40 Storm Grey
- 44 Nordic Blue
- 45 Green Khaki
- 46 Dark Sand
- 47 Taupe
- 49 Char Grey

Leathers:

- Natural
- Cognac
- Dark Brown
- Black

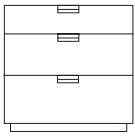

Frame Drawer Low

H: 70 cm
D: 42 cm
W: 80 cm

Three drawers

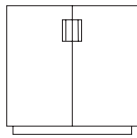

Frame 80 Low (covered doors)

H: 70 cm
D: 37 alt. 42 cm
W: 80 cm

Sliding door.
Including one lacquered shelf.

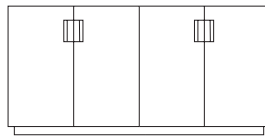

Frame 160 Low (covered doors)

H: 70 cm
D: 37 alt. 42 cm
W: 160 cm

2 sliding doors.
Including two lacquered shelves



(temporarily unavailable)

Frame 40 Low
Office (covered doors)



Frame Drawer
40 Low Office

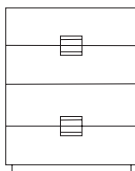

Frame Drawer Medium

H: 90 cm
D: 42 cm
W: 80 cm

Two medium and Two large drawers

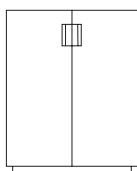

Frame 80 Medium (covered doors)

H: 90 cm
D: 37 alt. 42 cm
W: 80 cm

Sliding door.
Including two lacquered shelves.

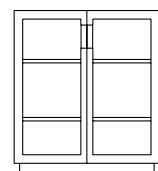

Frame 80 Medium (Glass doors)

H: 90 cm
D: 37 alt. 42 cm
W: 80 cm

Sliding door in glass.
Including two lacquered shelves.

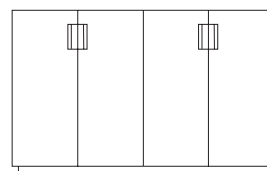

Frame 160 Medium (covered doors)

H: 90 cm
D: 37 alt. 42 cm
W: 160 cm

2 sliding doors.
Including four lacquered shelves.

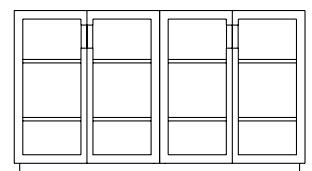

Frame 160 Medium (Glass doors)

H: 90 cm
D: 37 alt. 42 cm
W: 160 cm

2 sliding doors in glass.
Including four lacquered shelves.

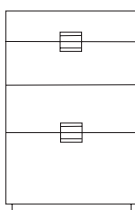

Frame Drawer High

H: 108 cm
D: 42 cm
W: 80 cm

One medium, two large and one XL drawer

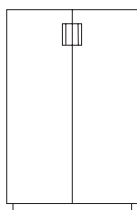

Frame 80 High (covered doors)

H: 108 cm
D: 37 alt. 42 cm
W: 80 cm

Sliding door.
Including two lacquered shelves.

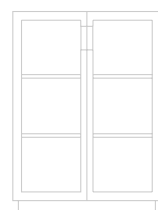

(temporarily unavailable)
Frame 80 High (Glass doors)

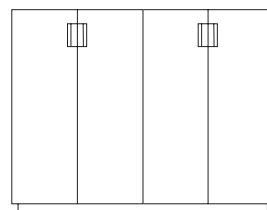

Frame 160 High (covered doors)

H: 108 cm
D: 37 alt. 42 cm
W: 160 cm

2 sliding doors.
Including four lacquered shelves.

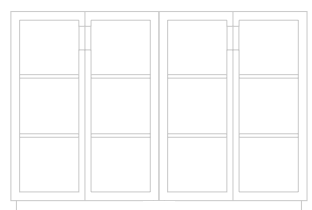

(temporarily unavailable)
Frame 160 High (Glass doors)

ASPLUND

Fotograf: Louise Billgert



05 Light Grey	15 White	40 Storm Grey	44 Nordic Blue	45 Green Khaki
46 Dark Sand	47 Taupe	49 Char Grey	Natural	
			Cognac	
			Dark Brown	
			Black	

FRAME SERIES XL

By Anya Sebton & Eva Lilja Löwenhielm 2011

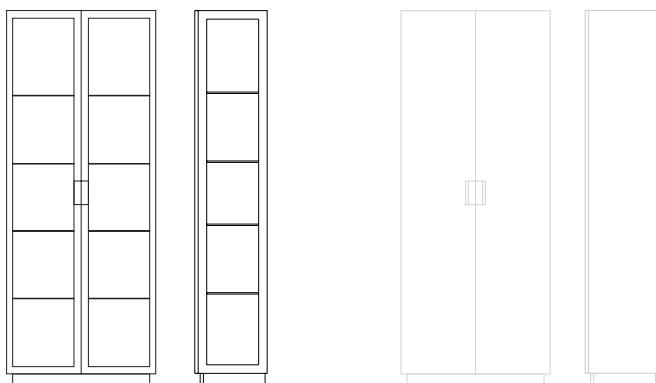

Frame XL (Glass doors)

H: 206 cm (base 6 cm)
D: 37 cm
W: 80 cm

Cabinet with glass doors and covered sides.

Highest cabinet in the Frame series, with handles in leather.

Two glass doors and standard hinges. Glass doors have glass shelves, one shelf is fixed with a metal fixings.

Additional:

Frame XL left side in glass
Frame XL right: Right side in glass

Distance brackets can be ordered to be mounted on the upper back edge. (especially if designated room has large floor lists)

(Temporarily unavailable)
Frame XL (Covered doors)

Colours Frame XL:

05 Light Grey
15 White
40 Storm Grey
44 Nordic Blue
45 Green Khaki
46 Dark Sand
47 Taupe
49 Char Grey

Leather:

Natural
Cognac
Dark Brown
Black

ASPLUND

Fotograf: Louise Billgert



Frame XL (Glass Doors)

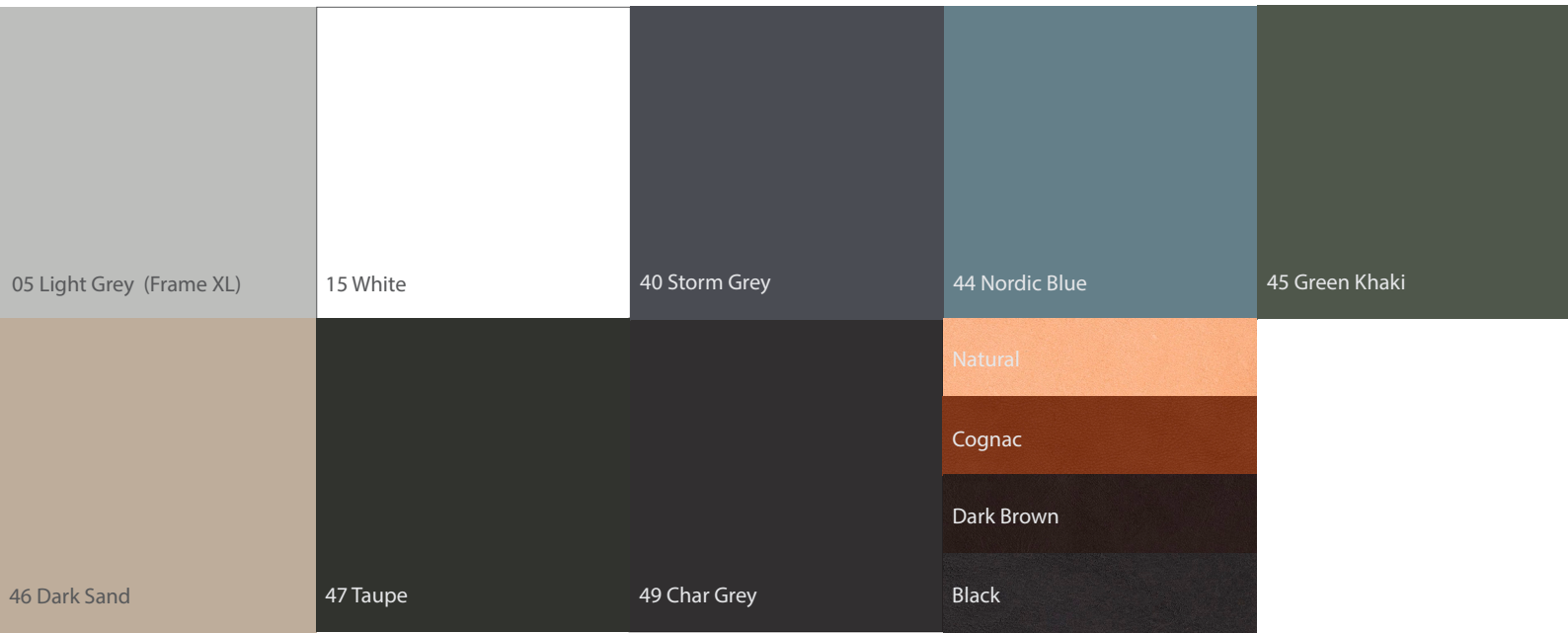

05 Light Grey (Frame XL)

15 White

40 Storm Grey

44 Nordic Blue

45 Green Khaki

46 Dark Sand

47 Taupe

49 Char Grey

Natural

Cognac

Dark Brown

Black

FRAME TV/MEDIA CABINET

By Anya Sebton & Eva Lilja Löwenhielm 2011

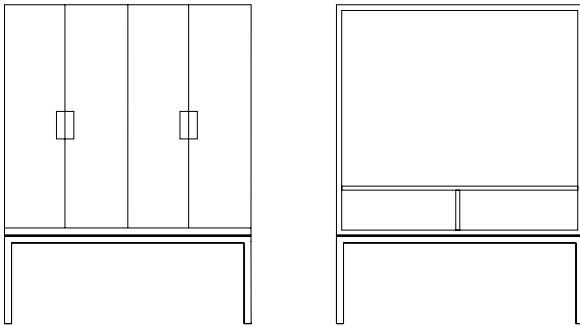

TV Cabinet:
15 White
40 Storm Grey
44 Nordic Blue
45 Green Khaki
46 Dark Sand
47 Taupe
49 Char Grey

Frame TV Cabinet

H: 150 cm (base 41 cm)
W: 120 cm
D: 40 cm

Cabinet i lacquered MDF with folding doors. Stand i lacquered metal with a fixed channel for cords.

One fixed shelf in oak veneer (with space for cords) and a divider (same colour as cabinet) is included.

Choose leather:

Natural leather = Shelf in White Stained Oak (P2).

Black, Brown or Cognac leather = Shelf in Black Walnut Oak (P4).

Maximum dimensions for TV: 46". Inside measure for TV: W116xH78xD36cm. Lower storage spaces: W57xH25xD36 cm
Adjustable feet.



ASPLUND

Frame TV cabinet (Storm Grey)



Fotograf: Louise Billgert

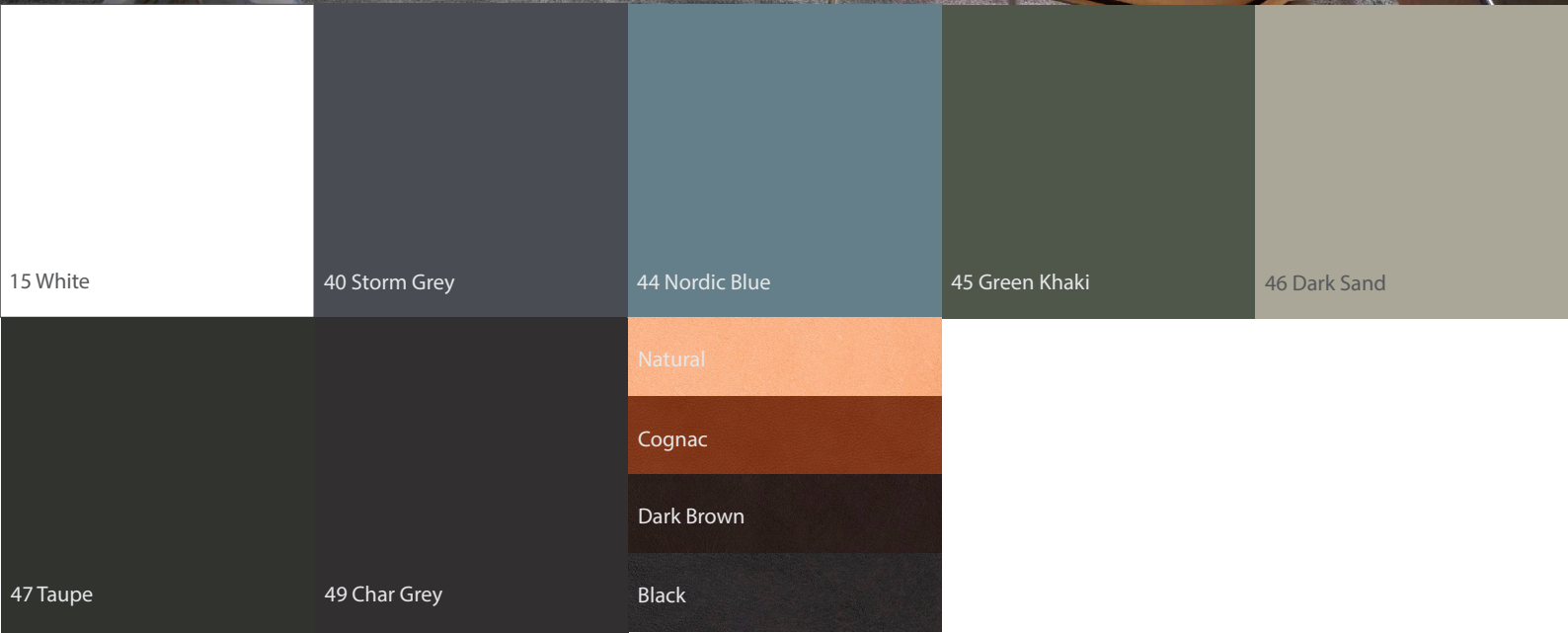

FRAME CABINET

By Anya Sebton & Eva Lilja Löwenhielm 2011

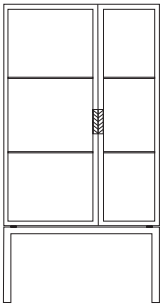

Frame Cabinet

H: 170 cm (stand 43 cm)

D: 40 cm

W: 90 cm

Glass cabinet in lacquered MDF, glass and metal with twined leather handles.

Including two glass shelves.

Colours Frame Cabinet:

15 White

40 Storm Grey

44 Nordic Blue

45 Green Khaki

46 Dark Sand

47 Taupe

49 Char Grey

Leather:

Natural

Cognac

Dark Brown

Black

FRAME SEMI CABINET

By Anya Sebton & Eva Lilja Löwenhielm 2011

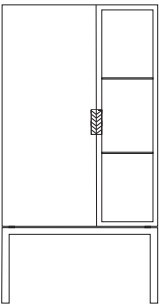

Frame Semi Cabinet

H: 170 cm (stand 43 cm)

D: 40 cm

W: 90 cm

Glass cabinet in lacquered MDF, glass and metal with twined leather handles.

Left side has a covered door with two lacquered shelves and the right side has a glass door with two glass shelves behind.

ASPLUND

Fotograf: Louise Billgert



BESSON DELUXE (temporarily unavailable)

By Broberg & Ridderstråle 2015

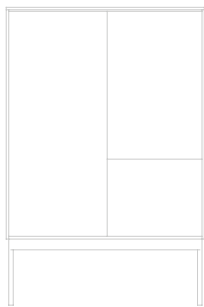

Besson Deluxe 100:1

ASPLUND

Fotograf: Louise Billgert



15 White	40 Storm Grey	30 Deep Blue	47 Taupe
Brushed Brass Laminate	Brushed Brass Laminate	Brushed Brass Laminate	Brushed Bronze Laminate
30 Deep Blue	44 Nordic Blue	Turquoise	40 Storm Grey
P2 White Stained Oak (Veneer)	P4 Black Walnut Oak (Veneer)	P2 White Stained Oak (Veneer)	P6 Dark Smoked Oak (Veneer)

Xí CABINET (temporarily unavailable)

By Pia Wallén 2017

Colour:
49 Char Grey
50 Xína Red

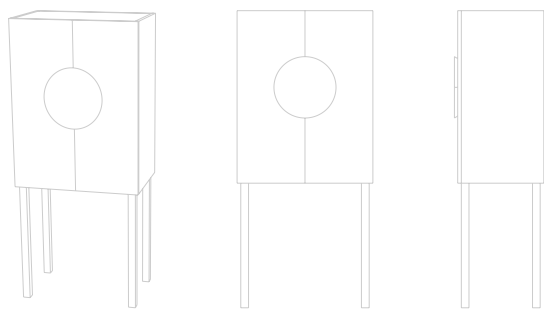

Xí Cabinet

ASPLUND

Fotograf: Louise Billgert

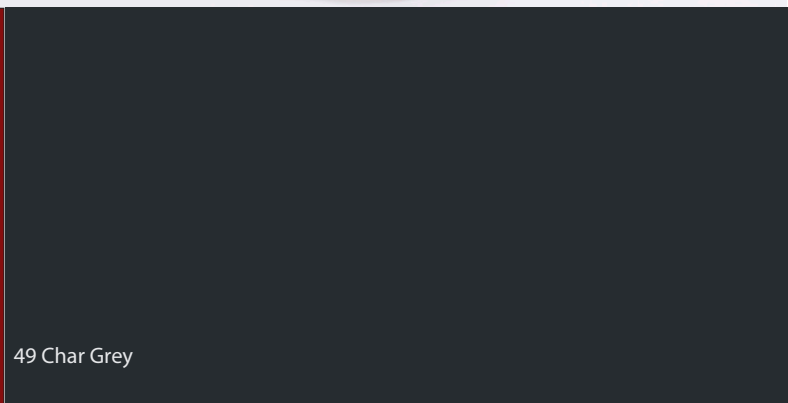

50 Xina Red

49 Char Grey





Palais Royal (White Stained Oak)

PALAIS SERIES

By Anya Sebton & Eva Lilja Löwenhielm 2018

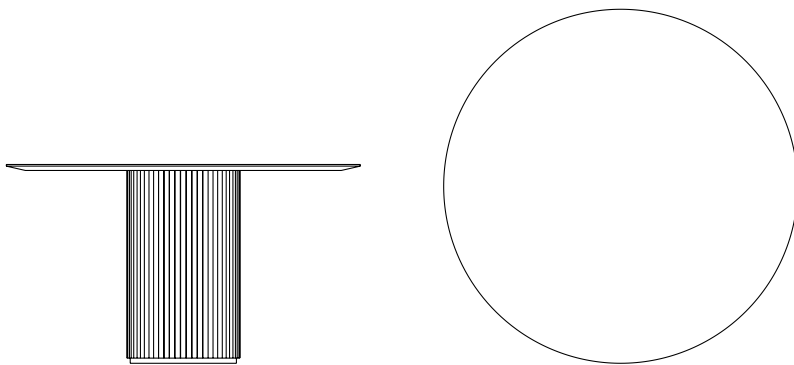

Palais Royal
Dining / Entrance table

H: 73 cm
Ø: 130 cm

Round table with base in solid oak panels. Top in 3 options with a solid oak edge in the same colour as the base. Polyurethane treated stained oak.
Top: Stained Oak.
Base: Stained Oak.

Available Colour Options:
Dark Grey Stained Oak
Teak Stained Oak
White Stained Oak (P2)
Natural Oak (P1)

Laminate on request.

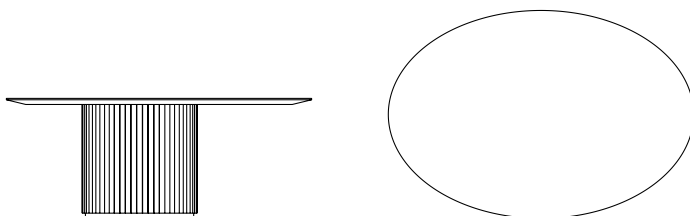

Palais Ovale
Coffee table

H: 43 cm
D: 75 cm
W: 110 cm

Oval sofa table with solid oak panel. Polyurethane lacquered top. Extra weight in the base for stability. Delivered with base and top separately.
Table: Stained Oak.

Available Colour Options:
Dark Grey Stained Oak
Teak Stained Oak
White Stained Oak (P2)
Natural Oak (P1)

Laminate on request.

ASPLUND

Fotograf: Louise Billgert



Palais Ovale (White Stained Oak)

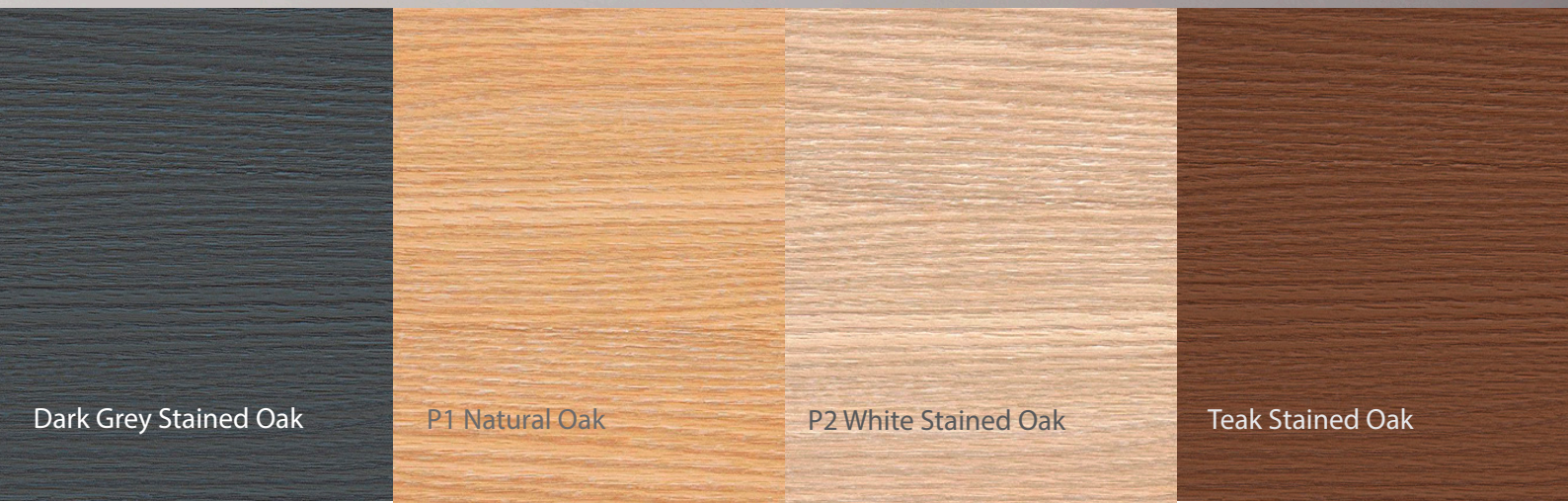

Dark Grey Stained Oak

P1 Natural Oak

P2 White Stained Oak

Teak Stained Oak

PALAIS SERIES

By Anya Sebton & Eva Lilja Löwenhielm 2018

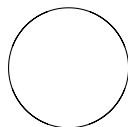
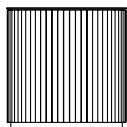

Petit Palais
Side Table H:42

H: 42 cm
Ø: 42 cm

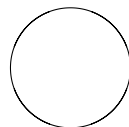
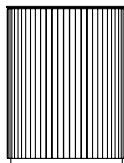

Petit Palais
Side Table H:55

H: 55 cm
Ø: 42 cm

Side and Coffee table with veneered or a solid stone Carrara top. Veneered tops are coated with polyurethane lacquer. Marble tops has a refillable nano treatment.

Top: Stained Oak or Solid Stone.

Base: Stained Oak.

Available Colour Options:

Dark Grey Stained Oak

Teak Stained Oak

White Stained Oak (P2)

Natural Oak (P1)

Dusty Pink

Laminate on request.

Top in Veneer or Carrara marble.

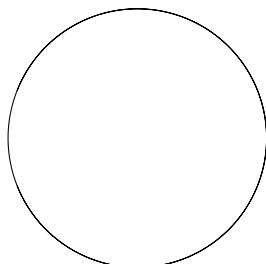
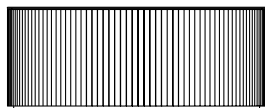

Grand Palais
Coffee Table

H: 37 cm
Ø: 92cm

Coffee table with a solid oak panel. Polyurethane treated stained oak.

Top: Stained Oak.

Base: Stained Oak.

Available Colour Options:

Dark Grey Stained Oak

Teak Stained Oak

White Stained Oak (P2)

Natural Oak (P1)

Dusty Pink

Laminate on request.

ASPLUND

Fotograf: Louise Billgert

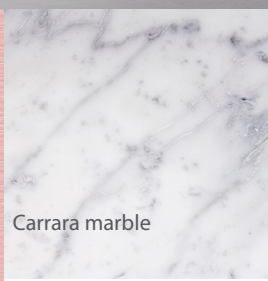

Dark Grey Stained Oak

Teak Stained Oak

P2 White stained Oak

P1 Natural Oak

Dusty Pink Oak

Carrara marble

PAGODA SERIES

By Broberg & Ridderstråle 2018

Available Colour Options:

- Option 1: Char Grey (P5) Shelves, Char Grey Structure.
- Option 2: Green Khaki (P5) Shelves, Green Khaki Structure.
- Option 3: Nougat (P5) Shelves, Nougat Structure.
- Option 4: White (P5) Shelves, White Structure.

Pagoda High

Floor standng, wall mounted

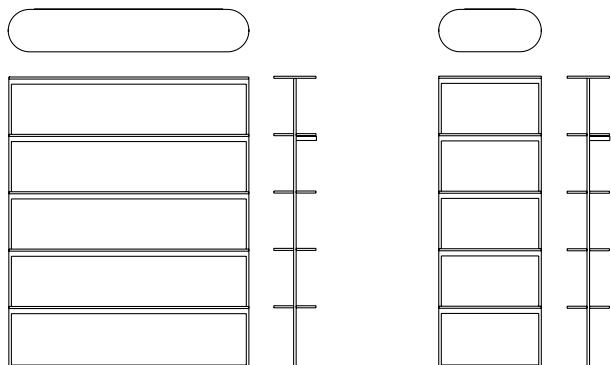

Pagoda 140:5

H: 171 cm
W: 140 cm
D: 26 cm

Pagoda 60:5

H: 171 cm
W: 60cm
D: 26 cm

Wall shelf units. Pagoda 140:5 and Pagoda 60:5 with 5 shelves. Unit comes with adjustable feet.

-Screws for attachment to wall are not included.

Pagoda Low

Free standing

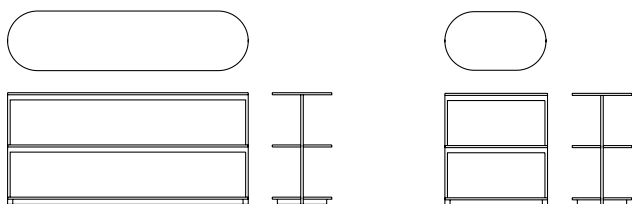

Pagoda 140:3

H: 65 cm
W: 140 cm
D: 35 cm

Pagoda 60:3

H: 65 cm
W: 60 cm
D: 35 cm

Free standing shelf unit. Pagoda 140:3 and Pagoda 60:3 with 3 shelves. Comes with adjustable feet.

ASPLUND

Fotograf: Louise Billgert

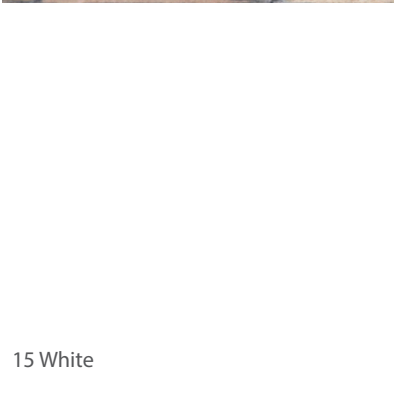

15 White

35 Nougat

45 Green Khaki

49 Char Grey

White Oak

Nougat Oak

Green Khaki Oak

Char Grey Oak

OBLIQUE SLIDING TABLES

By Claesson Koivisto Rune 2018

Colour:
48 Bronze

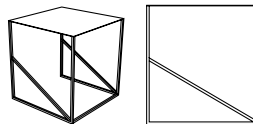
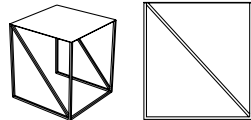
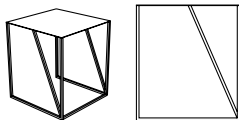
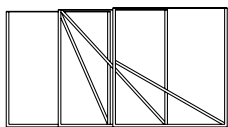

Oblique Sliding Table Low

H: 44 cm
W: 38 cm
D: 40 cm

Oblique Sliding Table Medium

H: 45 cm
W: 41 cm
D: 42 cm

Oblique Sliding Table High

H: 46 cm
W: 44 cm
D: 44 cm

Sliding tables with square steel rod and a thin metal plate top. Oblique Sliding Tables Family consists of all three tables. All three tables can be slided into each other.

Material: Powder Coated Bronze Metal.

Available Colour Options

Powder Coated Metal: Bronze.

ASPLUND



Fotograf: Louise Billgert



OBLIQUE COFFEE TABLE

By Claesson Koivisto Rune 2018

Colour:
48 Bronze

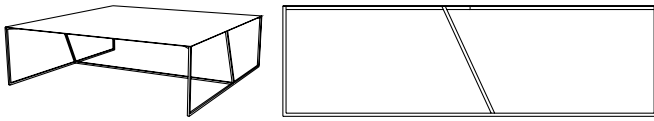

Oblique Square Coffee Table

H: 35 cm
W: 118 cm
D: 118 cm

Sofa table available in two sizes with square steel rod and a thin metal plate top.

Material: Powder Coated Metal.

Available Colour Options

Powder Coated Metal: Bronze.

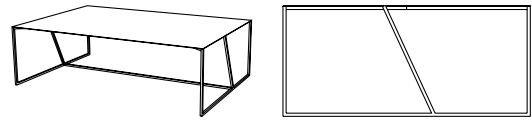

Oblique Rectangular Coffee Table

H: 35 cm
W: 118 cm
D: 78 cm

OBLIQUE DESK / SIDETABLE

By Claesson Koivisto Rune 2018

Colour:
48 Bronze

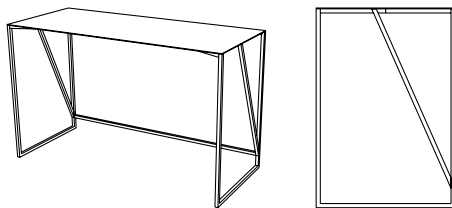

Oblique Desk

H: 72 cm
W: 118 cm
D: 50 cm

Desk with square steel wires and a thin metal plate top.

Material: Powder Coated Metal.

Available Colour Options

Powder Coated Metal: Bronze.

ASPLUND



Fotograf: Louise Billgert

BERMUDA

Av Thomas Eriksson 2006

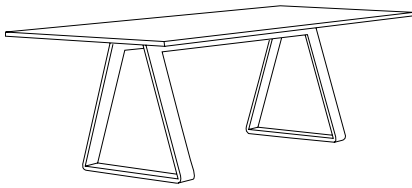

Bermuda Table

H: 72 cm
D: 90 cm
W: 200 cm

Solid colour laminated, White

H: 72 cm
D: 90 cm
W: 240 cm

Solid colour laminated, White

H: 72 cm
D: 90 cm
W: 280 cm

Solid colour laminated, White

Colour:
White 15

Top:
Color core laminate
Nano laminate (On request)

Tables with metal stand and solid colour laminated top with polyurethane lacquered edges and underside.
Delivered in flat pack. Stands: W = 10 cm each. Bermuda Table 200x90 cm and 240x90 cm: the open space between the stands is 130 cm wide. Bermuda Table 280x90 cm: the open space between the stands is 170 cm wide.
Red Dot Award winner.

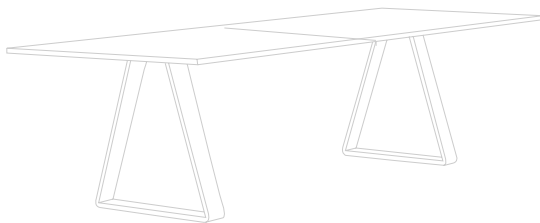

Bermuda Mega Table (Temporarily unavailable)



(Temporarily unavailable)

ASPLUND

Fotograf: Louise Billgert



TATI

By Broberg & Ridderstråle 2011

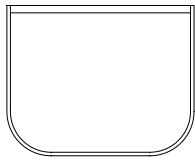

Tati Coffee Table 63,5 High (square)

H: 50 cm
W: 63,5 cm
L: 63,5 cm

Frame: Lacquered metal

Top:
Stone
Oak
Glass

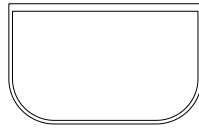

Tati Coffee Table 63,5 Low (square)

H: 40 cm
W: 60,5 cm
L: 63,5 cm

Frame: Lacquered metal

Top:
Stone
Oak

Colours frame:

- 15 White
- 35 Nougat
- 40 Storm Grey
- 44 Nordic Blue
- 45 Green Khaki
- 48 Bronze *
- 49 Char Grey

Glass:

- Glass
- Lacquered glass in the same colour as the frame*
- White Glass
- *Not available in Bronze.

Top:

- Oak:**
- P2 - White Stained Oak
 - P4 - Black Walnut Oak
 - P6 - Dark Smoked Oak
- Stone:**
- Cararra marble
 - Nuvolato marble
 - Belgian limestone
 - Jura limestone

PLEASE NOTE!

Shelves for Bronze Tables are made in oak veneer P6.

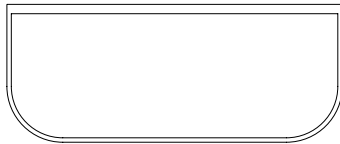

Tati Coffee Table 90 High

H: 37 cm
W: 90 cm
L: 90 cm

Frame: Lacquered metal

Top:
Stone
Oak
Glass
Lacq. glass*

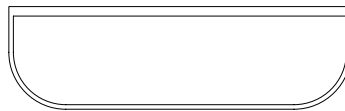

Tati Coffee Table 90 Low

H: 27 cm
W: 87 cm
L: 90 cm

Frame: Lacquered metal

Top:
Stone
Oak
Lacq. glass*

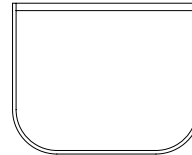

Tati Lounge 65

H: 51 cm
W: 48 cm
L: 65 cm

Frame: Lacquered metal

Top:
Stone
Glass
Lacq. glass*



Tati Lounge 120

H: 40 cm
W: 40 cm
L: 120 cm

Frame: Lacquered metal

Top:
Stone
Lacq. glass*

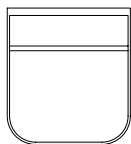

Nati Tati Console

H: 55 cm
W: 40 cm
L: 45 cm

Frame: Lacquered metal, shelf in MDF.

Top:
Stone
Oak

Shelf: Same as stand, Bronze has a oak veneer shelf.

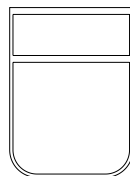

Nati Tati Console High

H: 62 cm
W: 40 cm
L: 45 cm

Frame: Lacquered metal, shelf in MDF.

Top:
Stone
Oak

Shelf: Same as stand, Bronze has a oak veneer shelf.

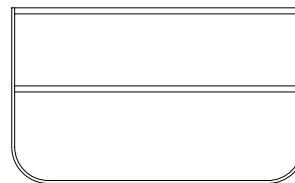

Tati Console 120

H: 72 cm
W: 40 cm
L: 120 cm

Frame: Lacquered metal, shelf in lacquered MDF.

Top:
Stone
Oak
Lacq. glass*

Shelf: Same as stand, Bronze has a oak veneer shelf.

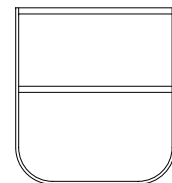

Tati Console 65

H: 72 cm
W: 40 cm
L: 65 cm

Frame: Lacquered metal, shelf in lacquered MDF.

Top:
Stone
Oak P4
Lacq. glass*

Shelf: Same as stand, Bronze has a oak veneer shelf.

ASPLUND

Fotograf: Louise Billgert

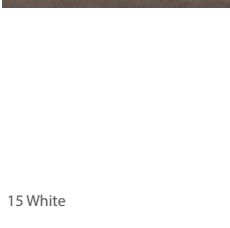

P2 White Stained Oak



35 Nougat

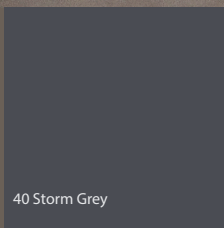

40 Storm Grey

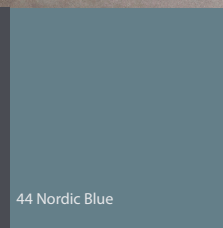

44 Nordic Blue

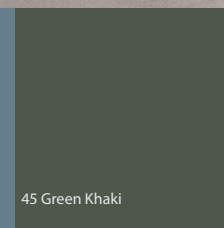

45 Green Khaki

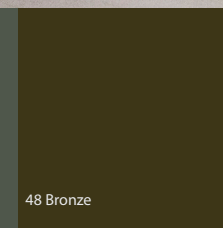

48 Bronze



49 Char Grey



P2 White Stained Oak



P4 Black Walnut Oak



P6 Dark Smoked Oak



Belgian limestone



Carrara marble

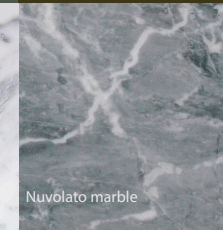

Nuvolato marble



Jura limestone

TATI SERIES

By Broberg & Ridderstråle for 2012

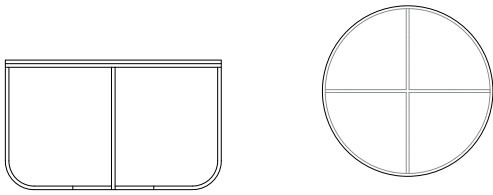

Tati Dining Table Round 120 Ø

Ø: 120 cm
H: 72 cm*

Round table with lacquered metal frame.

Top: Stone
Cararra marble, Nuvolato marble, Belgian limestone,
Jura limestone

*Adjustable feet will add from 0,5 cm to the height.

Delivered fully assembled. Marble top separate.

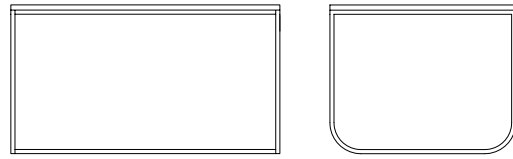

Tati Dining Table 140

H: 72 cm*
W: 85 cm
L: 140 cm

Rectangular table. Frame in lacquered metal.

Top:
Stone: Cararra marble, Nuvolato marble, Belgian limestone,
Jura limestone
Oak: P1, P2, P4.

*Adjustable feet will add from 0,5 cm to the height.

The oak top comes with a clear protective top coat of polyurethane lacquer.

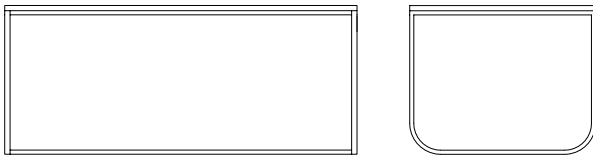

Tati Dining Table 200

H: 72 cm*
W: 85 cm
L: 200 cm

Dining or work table with a frame in lacquered metal and a table top in selected 1,6 mm thick oak veneer.

Top:
Oak : P1, P2, P4.

*Adjustable feet will add from 0,5 cm to the height.

The oak top comes with a clear protective top coat of polyurethane lacquer.
Frame and top are delivered unassembled in flat pack

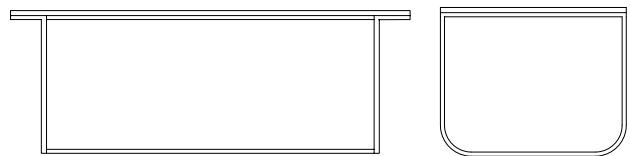

Tati Dining Table 200 (extended top)

H: 72 cm*
W: 85 cm
L: 200 cm

Dining or work table with a frame in lacquered metal and a table top in selected oak veneer. With an overhang of 30 cm on each short side.

Top:
Oak: P1, P2, P4.

*Adjustable feet will add from 0,5 cm to the height.

The oak top comes with a clear protective top coat of polyurethane lacquer.
Frame and top are delivered unassembled in flat pack

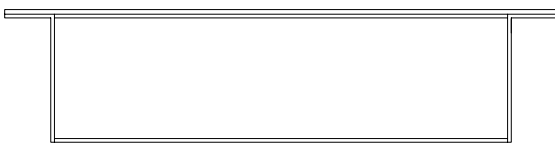

Tati Dining Table 260 (extended top)

H: 72 cm*
W: 85 cm
L: 260 cm

Dining or work table with a frame in lacquered metal and a table top in selected 1,6 mm thick oak veneer.

Top:
Oak : P1, P2, P4.

*Adjustable feet will add from 0,5 cm to the height.

The oak top comes with a clear protective top coat of polyurethane lacquer.
Frame and top are delivered unassembled in flat pack

ASPLUND

Fotograf: Louise Billgert

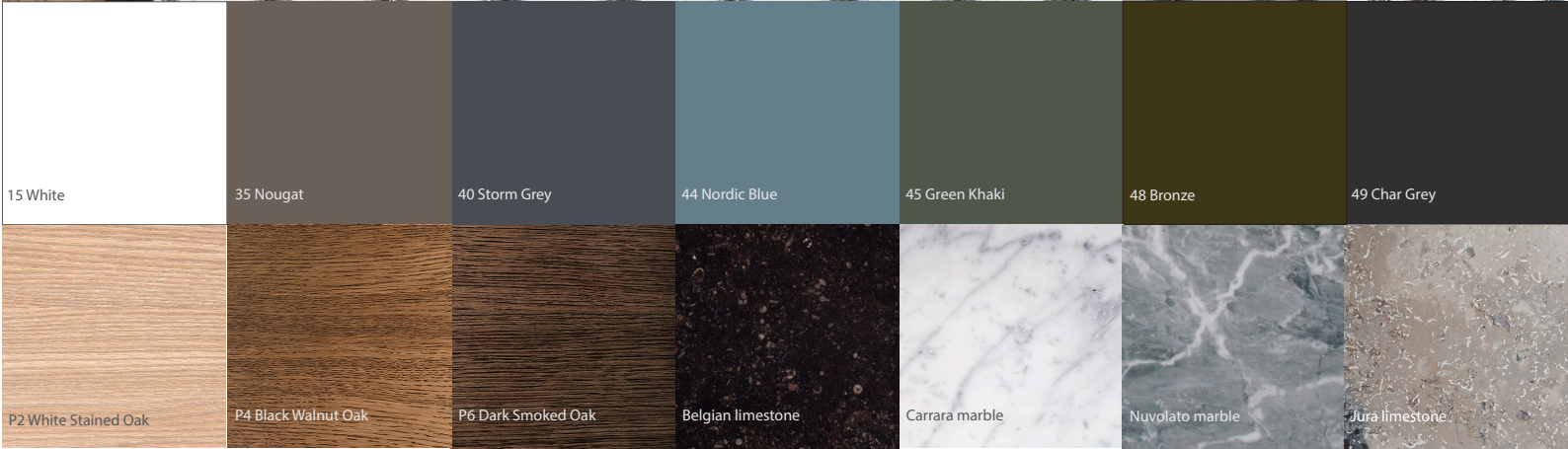

15 White

35 Nougat

40 Storm Grey

44 Nordic Blue

45 Green Khaki

48 Bronze

49 Char Grey

P2 White Stained Oak

P4 Black Walnut Oak

P6 Dark Smoked Oak

Belgian limestone

Carrara marble

Nuvolato marble

Jura limestone

TATI DESK

By Broberg & Ridderstråle for 2012

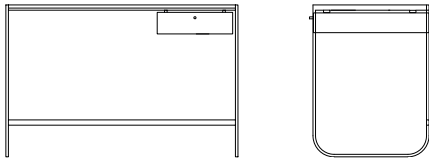

Tati Desk

H: 72 cm

D: 55 cm

B: 110 cm

Desk with lacquered metal frame. Optional addition of 1-3 drawers in selected oak veneer with a brass knob.

Top:

Oak:** P2, P4 or P6.

Polyurethane lacquer (temporarily unavailable)

Additional:

Drawer in oak veneer: P2, P4 or P6

*Always to be ordered in same colour of the top and frame.

Delivered fully assembled.

TATI NIGHT TABLE

By Broberg & Ridderstråle for 2012

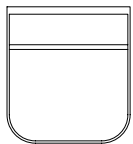

Nati Tati Console

H: 55 cm

W: 40 cm

L: 45 cm

Frame: Lacquered metal, shelf in MDF.

Top:

Stone

Oak : P2, P4, P6

Lacquered MDF: White, Storm grey, Char Grey, Nordic Blue, Green Khaki.

Shelf: Same as stand or oak veneer.

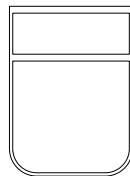

Nati Tati Console High

H: 62 cm

W: 40 cm

L: 45 cm

Frame: Lacquered metal, shelf in MDF.

Top:

Stone

Oak: P2, P4, P6

Lacquered MDF: White, Storm grey, Char Grey, Nordic Blue, Green Khaki.

Shelf: Same as stand or oak veneer.

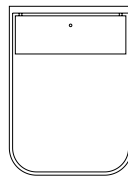

Nati Tati Drawer High

H: 62 cm

W: 40 cm

L: 45 cm

Frame: Lacquered metal, shelf in MDF.

Top in Oak: P2, P4, P6

Shelf: Same as stand or oak veneer.

ASPLUND

Fotograf: Louise Billgert

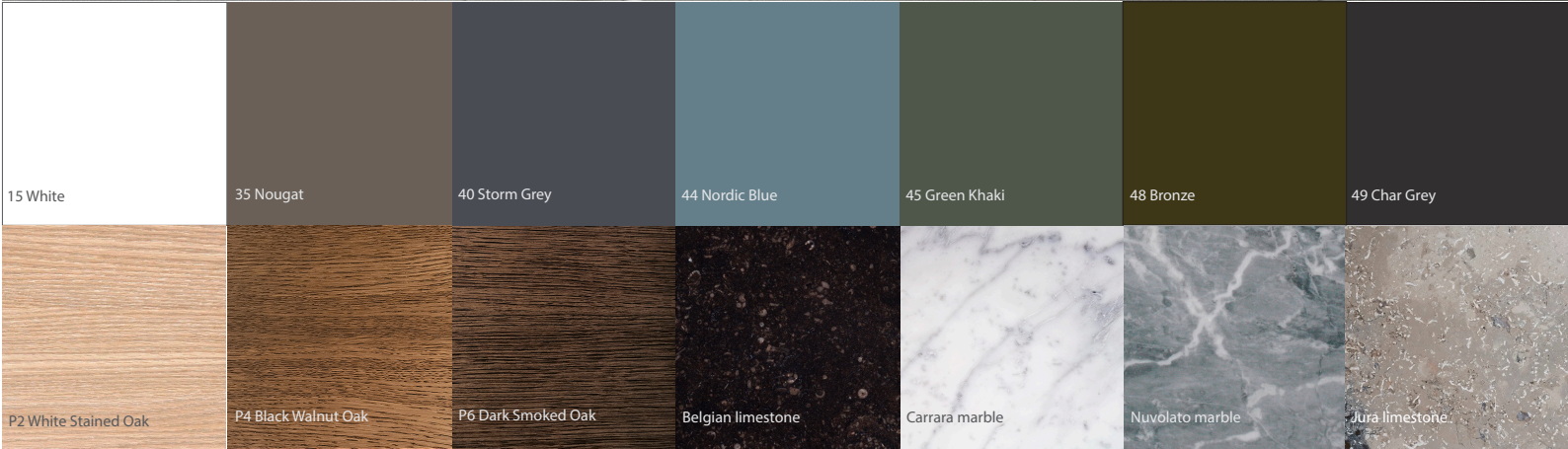

15 White

35 Nougat

40 Storm Grey

44 Nordic Blue

45 Green Khaki

48 Bronze

49 Char Grey

P2 White Stained Oak

P4 Black Walnut Oak

P6 Dark Smoked Oak

Belgian limestone

Carrara marble

Nuvolato marble

Jura limestone

PLECTRA

By Thomas Sandell & Mattias Stenberg 2016

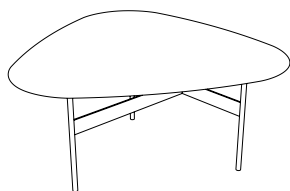

Plectra Coffee table Medium

H: 42 cm
W: 86 cm
D: 82 cm

Sofa table with a lacquered metal stand and top in solid ash.

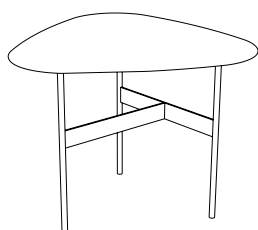

Plectra Coffee table Small High

H: 52 cm
W: 63 cm
D: 65 cm

Sofa table with a lacquered metal stand and top in solid ash.

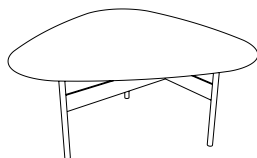

Plectra Coffee table Small Low

H: 31,5 cm
W: 63 cm
D: 65 cm

Sofa table with a lacquered metal stand and top in solid ash.

Top:
AP2 - White Stained Ash

Colour of stand:
15 White
35 Nougat
40 Storm Grey
44 Nordic Blue
45 Green Khaki
48 Bronze*
49 Char Grey
* Bronze has a surcharge of 5%.

ASPLUND

Fotograf: Louise Billgert



AIR

By Thomas Sandell 1991

Colour:
15 White
45 Green Khaki
48 Bronze
49 Char Grey
Galvanized Zink

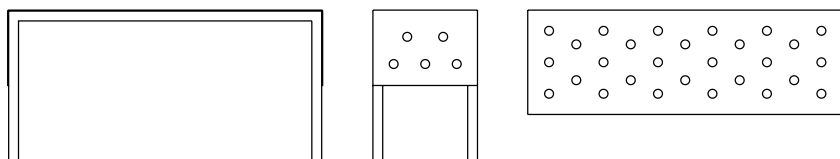

Air Bench

H: 46cm
D: 32cm
W: 96cm

Bench in lacquered metal. For indoor and outdoor use.

ASPLUND



Fotograf:
Tina Billgert

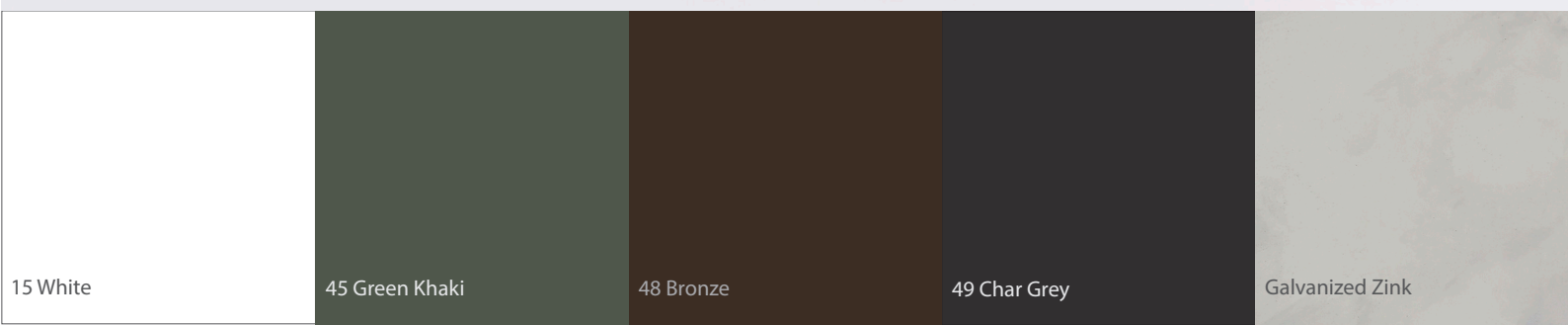

15 White

45 Green Khaki

48 Bronze

49 Char Grey

Galvanized Zink

BELLE PETIT

By Broberg & Ridderstråle 2016

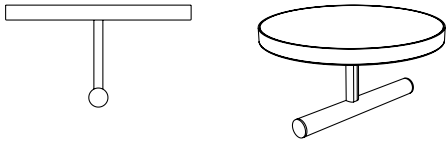

Belle Petit Coat Rack

H: 17 cm
ø: 31 cm

Coat rack in lacquered metal with a leather wrapped rail.
Top shelf in oak veneer.
(screws for attachment to wall not included)

Colour options:

1. White with cognac leather with top in White Stained Oak (P2)
2. Char Grey with cognac leather with top in Dark Smoked Oak (P6)
3. Green Khaki with cognac leather with top in Dark Smoked Oak (P6)

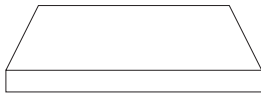

Belle Petit Shoe plate

H: 3 cm
W: 31 cm
D: 31 cm

Squared shoe plate in lacquered metal.
Insert in natural coconut fibre or oak veneer in White Stained
Oak (P2) or Dark Smoked Oak (P6)

Colour of frame:

White, Char Grey or Green Khaki

BELLE

By Broberg & Ridderstråle 2016

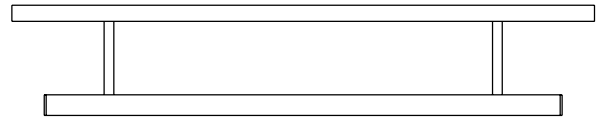

Belle Coat Rack

H: 17 cm
W: 90 or 120 cm
D: 31 cm

Coat rack in lacquered metal with a leather wrapped rail.
Top shelf in oak veneer.
(screws for attachment to wall not included)

Colour options:

1. White with cognac leather with top in White Stained Oak (P2)
2. Char Grey with cognac leather with top in Dark Smoked Oak (P6)
3. Green Khaki with cognac leather with top in Dark Smoked Oak (P6)



Belle Shoe plate

H: 3 cm
W: 90 or 120 cm
D: 31 cm

Rectangular shoe plate in lacquered metal.
Insert in natural coconut fibre.

Colour of frame:

White, Char Grey or Green Khaki

ASPLUND

Fotograf: Louise Billgert



15 White

45 Green Khaki

49 Char Grey

Cognac

Cognac

Cognac

TATI MIRROR

By Broberg & Ridderstråle for 2011

Colours:
15 White
35 Nougat
40 Storm Grey
44 Nordic Blue
45 Green Khaki
48 Bronze
49 Char Grey

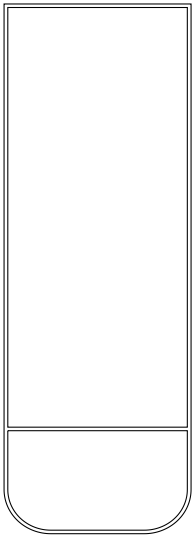

Tati Mirror L

H: 180 cm

W: 60 cm

D: 5 cm (distance from wall)

Wall hung or floor standing mirror.

Fram: Lacquered metal.

Colours: White, Nougat, Storm Grey, Nordic Blue, Green Khaki, Bronze and Char Grey.



ASPLUND



Fotograf: Louise Billgert

OTTO

By Anya Sebton & Eva Lilja Löwenhielm 2016

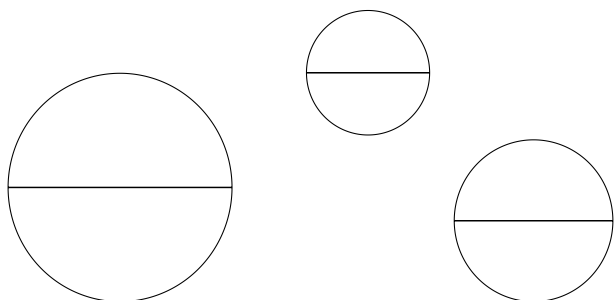

OTTO Mirror Round 110 Ø :

Ø: 110 cm

D: 12 cm (Shelf included)

OTTO Mirror Round 80 Ø :

Ø: 80 cm

D: 10 cm (Shelf included)

OTTO Mirror Round 60 Ø :

Ø: 60 cm

D: 10 cm (Shelf included)

Shelf and backside in colour.

Available Colour Options

Option 1: Char Grey Structure, Smoked Mirror.

Option 2: Bronze Structure, Bronze Mirror.

Option 3: Green Khaki Structure, Clear Mirror.

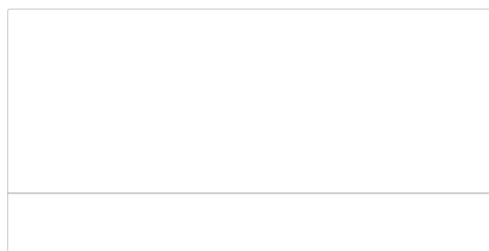

(temporarily unavailable)

Otto Mirror Rectangular:

ASPLUND

Fotograf: Louise Billgert



TATI COAT RACK

By Broberg & Ridderstråle for 2011

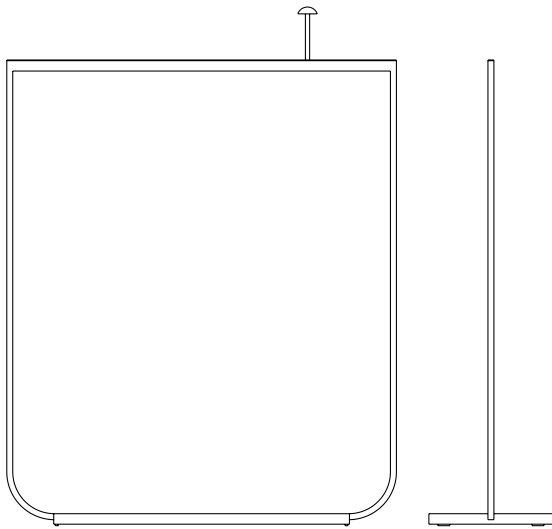

Tati Coat Rack Large 130

H: 155 cm
W: 130 cm
D: 41 cm

Floor standing coat hanger/rack in metal with brass details and stone base.
Structure: Powder Coated Metal.
Base / Insert: Solid Stone.

Available Colour Options

Powder Coated Metal:

48 Bronze
49 Char Grey
45 Green Khaki
44 Nordic Blue
35 Nougat
40 Storm Grey
15 White

Base Solid Stone:

Belgian Limestone
Carrara Marble
Jura Grey Limestone
Nuvolato Marble

Knob



Hooks



-Tati add Hooks (2 pcs) in brass.
-Tati add hat knob in brass.
Hooks and knobs are sold separately

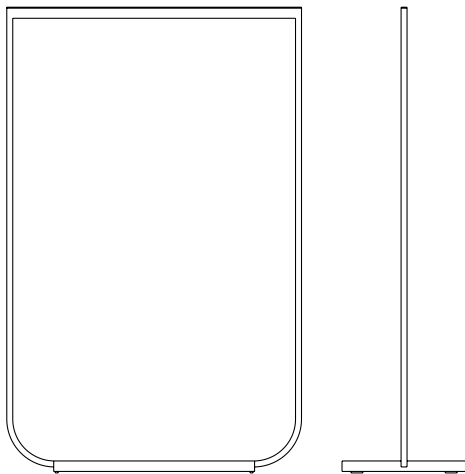

Tati Coat Rack Small 100

H: 155 cm
W: 100 cm
D: 41 cm

Floor standing coat hanger/rack in metal with brass details and stone base.
Structure: Powder Coated Metal.
Base / Insert: Solid Stone.

ASPLUND

Fotograf: Louise Billgert

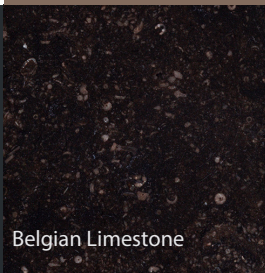
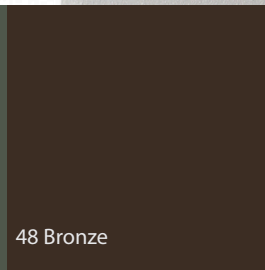
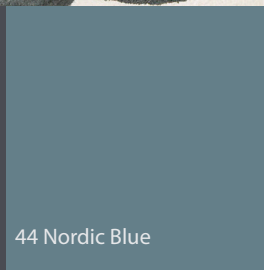
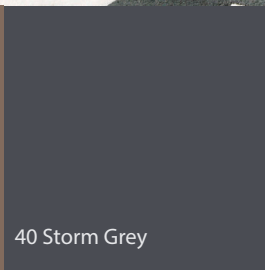
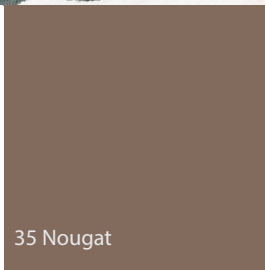
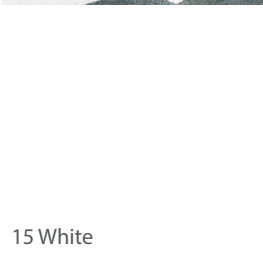

15 White

35 Nougat

40 Storm Grey

44 Nordic Blue

45 Green Khaki

48 Bronze

49 Char Grey

Belgian Limestone

Carrara Limestone

Nuvolato marble

Jura Limestone

