

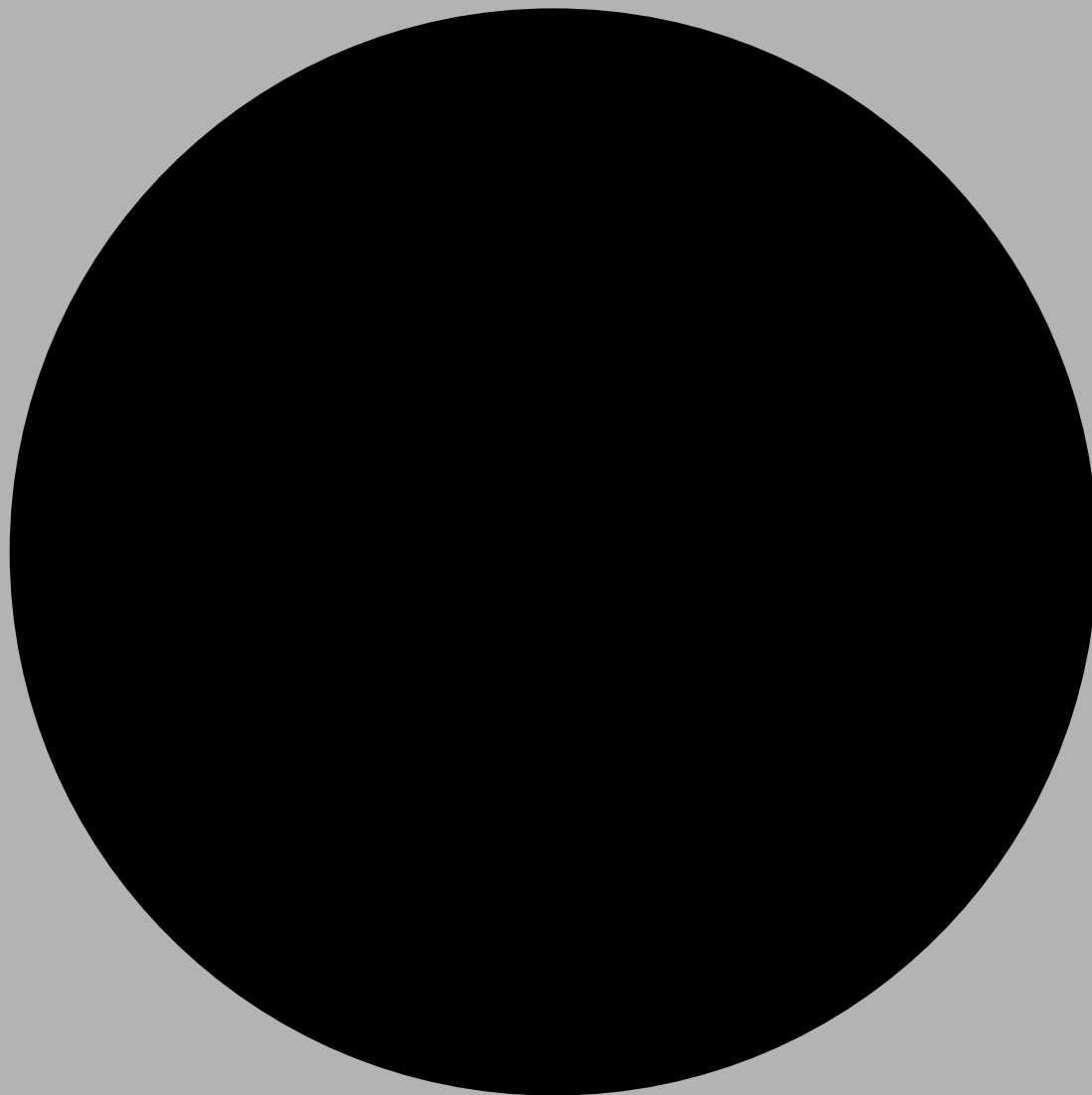



Black book



**SANCAL** 

## INDEX

SANCAL PHILOSOPHY ... 4  
DESIGNERS ... 8

## A

AIR ... 124  
ALPINO ... 26  
ARTICA ... 196

## B

BANG! ... 298  
BARNABY ... 90  
BEETLE ... 258  
BOOMERANG ... 164

## C

CASTA ... 162  
CHAT ... 238  
CITY ... 118  
CLUB ... 171  
COJINES ... 301  
COLLAR ... 188  
COPLA ... 98  
COSAS ... 307

## D

DB ... 58  
DEEP ... 64 SOFÁ, SOFA  
DEEP ... 297 COJÍN, CUSHION  
DUMBBELL ... 272  
DUO ... 130  
DUPLEX ... 280

## E

ELEPHANT ... 234  
ELEVA ... 128  
ESTANTE ... 254  
ESTOLA ... 296

## F

FLOAT ... 106 SOFÁ, SOFA  
FLOAT ... 306 PERCHERO, HOOK  
FOLK ... 102

## H

HAPPEN ... 114  
HE ... 291  
HERA ... 168

## I

INTERCHANGE ... 204 BANCO, BENCH  
INTERCHANGE ... 268 MESITA, OCCASIONAL TABLE

## K

KONOHA ... 220

## L

LA ISLA ... 208 SOFÁ, SOFA  
LA ISLA ... 270 MESITA, OCCASIONAL TABLE

## M

MAGNUM ... 148 BUTACA, ARMCHAIR  
MAGNUM ... 180 SILLA, CHAIR  
MAGNUM ... 244 TABURETE, STOOL  
MANDARINAS ... 299

MEETING POINT ... 228  
MENU ... 224  
MIDORI ... 200 SILLA, CHAIR  
MIDORI ... 248 TABURETE, STOOL  
MIND THE GAP ... 302  
MOON ... 132  
MOSAICO ... 214  
MOSS ... 170  
MOUSSE ... 48  
MULLIT ... 176

## N

NAP ... 138  
NEXT STOP ... 36  
NIDO ... 156 BUTACA, ARMCHAIR  
NIDO ... 186 SILLA, CHAIR  
NOMADA ... 169  
NOSSO ... 136  
NUDO ... 222 BANCO, BENCH  
NUDO ... 290 MESITA, OCCASIONAL TABLE

## O

OBI ... 70

## P

PARTY ... 300  
PERIGALLO ... 250  
PION ... 284

## R

REW ... 82 SOFÁ, SOFA  
REW ... 218 BANCO, BENCH  
REW ... 300 COJÍN, CUSHION  
ROCK ... 292

## S

SILENCIO ... 172  
SILLA 40 ... 192  
SOUL ... 166  
SUMO ... 94

## T

TAB ... 236  
TALO ... 158 BUTACA, ARMCHAIR  
TALO ... 300 COJÍN, CUSHION  
TARTANA ... 262  
TEA ... 110 SOFÁ, SOFA  
TEA ... 198 SILLA, CHAIR  
TEA ... 246 TABURETE, STOOL  
TECNO ... 300  
TIPTOE ... 78  
TONELLA ... 74 SOFÁ, SOFA  
TONELLA ... 152 BUTACA, ARMCHAIR  
TONELLA ... 240 PUF, TABURETE, POUF, STOOL  
TORTUGA ... 142 BUTACA, ARMCHAIR  
TORTUGA ... 276 MESA, TABLE

## V

VESPER ... 282



## **¡ÁNIMO, VALIENTE!**

¡Estamos contigo! Sabemos lo que se siente al iniciar un nuevo proyecto.

A través de estas páginas encontrarás inspiración y la felicidad que nos aporta un característico elenco de productos que ha sido diseñado para emocionar y perdurar.

## **HAVE COURAGE, BE BRAVE!**

You are not alone! We know what it's like to confront new a project.

Within these pages you will find inspiration and joy, products with character that are designed to thrill and last.



## DISEÑANDO LA FELICIDAD

Nuestros productos emanan felicidad porque a lo largo de todo el proceso creativo y durante su producción muchas personas han depositados en ellos lo mejor de sí mismas. Queremos transmitirte el placer que sentimos haciendo nuestro trabajo para que disfrutes diseñando espacios inspiradores. Queremos que te rodees de un entorno que te haga feliz o que proyectes espacios que hagan felices a otras personas.



## THE JOY OF DESIGN

Our products exude joie de vivre as, all those that play a part in the creative and production manufacturing processes, work with love and attention. We want you to enjoy the design process as much as we do, to create awe inspiring spaces. We want you to immerse yourself in an environment that makes you feel happy, or that your project might do the same for others.



# Diseñar Design

Nos confesamos adictos al espacio, las formas, el volumen, el color, los materiales, los conceptos... En definitiva a crear ambientes y solucionar los problemas del hábitat.

El diseño es un elemento central para Sancal. Desde nuestros inicios hemos apostado por ofrecer un producto singular, por ello trabajamos con estudios de diseño de muy diversa índole tanto prestigiosos, como noveles, y por supuesto, desde nuestro propio estudio.

We admit we are design-mad: addicted to spaces, shapes, volumes, colours, materials, concepts... In short, to the creation and enhancement of the living environment.

Design is the central element for Sancal. From our beginnings we have strived to offer a distinctive product, and that is why we work with diverse designers: prestigious studios, new studios, and, of course, our own design studio..



Estudiñac



Geckeler Michels



Karim Rashid



Santiago Castaño



Note



Marie Louise Rosholm

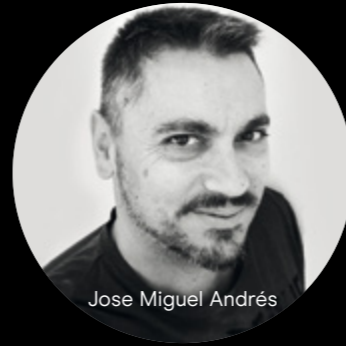

Jose Miguel Andrés



Quim Iarrea



Toyo Ito



Ricard Ferrer



Nachacht



Perrine vigneron & gilles belley



Mut



Ionna Vautrin



Enrique Martí



Isaac Piñeiro



Luca Nichetto



Ebuálá

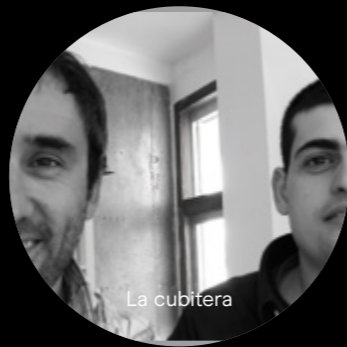

La cubitera

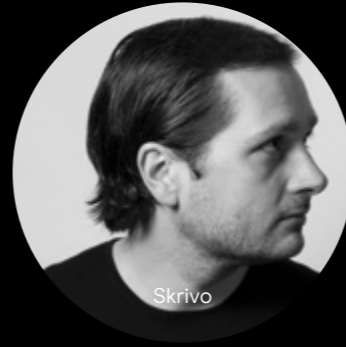

Skrivo

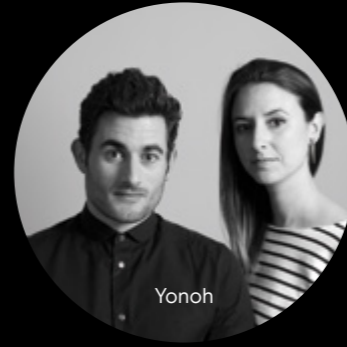

Yonoh



Sebastian Herkner

# Estudio Sancal

El Estudio Sancal nació con la finalidad de dar soporte técnico a los diseñadores freelance con los que Santiago Castaño comenzó a trabajar a mediados de los años '80.

Esther y Elena han convertido este pequeño atelier en el corazón creativo de la empresa. Con las dosis justas de tesón y locura, lideran un talentoso equipo multidisciplinar para desarrollar los más variados proyectos; desde una campaña de publicidad a la escenografía de toda una colección o productos tan singulares como los Perigallo.

The Sancal Studio was born with the purpose of giving technical support to the freelance designers with whom Santiago Castaño began working with in the mid-1980s.

Esther and Elena have turned this small atelier into the creative heart of the company. With the right doses of determination and madness, they lead a talented multidisciplinary team to develop the most varied of projects; from an advertising campaign to the scenography of a whole collection of products, some as unique as the Perigallo.





# Sofás

## Sofas



AIR 124



BARNABY 90



MOON 132



NEXT STOP 36



ALPINO 26



DB 58



MOSAICO 212



CITY 118



COPLA 98



DEEP 64



MOUSSE 48



NOSSO 136



OBI 70



DUO 130



ELEVA 128



FLOAT 106



REW 82



SUMO 94



TALO 158



FOLK 102



HAPPEN 114



LA ISLA 206



TEA 110



TIPTOE 78



TONELLA 74

# Chaise Longues



AIR 124



ALPINO 26



CITY 118



DEEP 64



DUO 130



FOLK 102



HAPPEN 114



MOSAICO 212



OBI 70



TIPTOE 78



NAP 138

# Sofás cama Sofas beds

# Sillas Dining Chairs



ARTICA 196



COLLAR 188



MAGNUM 180



MULLIT 176



MIDORI 200



NIDO 186



SILLA 40 192



TEA 198

# Estantería Bookcase



ESTANTE 250

# Sillones y butacas

## Lounge chairs and armchairs



ALPINO 26



ARTICA 196



MIDORI 200



MOON 132



MOSS 170



BARNABY 90



BOOMERANG 165



CASTA 162



NEXT STOP 36



NIDO 156



NOMADA 169



CLUB 171



COLLAR 188



COPLA 98



NOSSO 136



REW 82



SILENCIO 172



DB 58



DEEP 64



FOLK 102



SOUL 166



SUMO 94



TALO 158



HAPPEN 114



HERA 168



MAGNUM 148



TEA 110



TONELLA 152



TORTUGA 142

# Pufs Poufs



ALPINO 26



CHAT 236



DEEP 64



DUO 130



ELEPHANT 232



FOLK 102



KONOHA 218



MOON 132



MEETING POINT 226



MOSAICO 212



NEXT STOP 36



TONELLA 238



TORTUGA 142

# Taburetes Stools



TEA 244



MAGNUM 242



MIDORI 246



PERIGALLO 248



TONELLA 238



CHAT 236



NUDO 286



PION 280



TAB 234

# Bancos Benches



ELEPHANT 232



FLOAT 106



KONOHA 218



INTERCHANGE 202



LA ISLA 206

# Acústicos Acoustic products



ESTANTE 250



MENU 222



MOSAICO 212



MEETING POINT 226

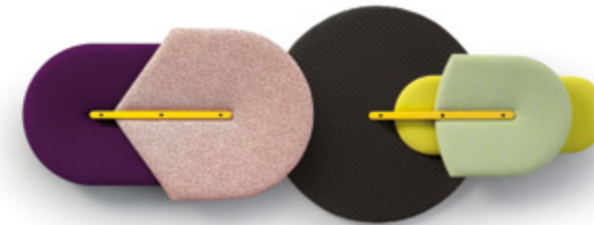

BEETLE 254

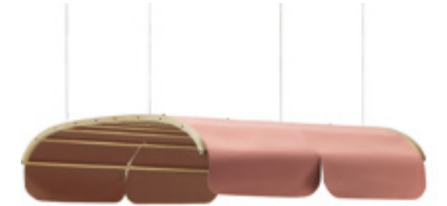

TARTANA 258



NEXT STOP 36



NUDO 220



REW 82

# Mesitas Occasional tables



DUMBBELL 268



DUPLEX 276

# Mesas Tables



DUMBBELL 268



PION 280



HE 287



INTERCHANGE 264



LA ISLA 266



TORTUGA 272



VESPER 278



MOSAICO 212



MOUSSE 48



NUDO 286



PION 280



ROCK 288



TAB 234



COJINES 297



DEEP 64



ESTOLA 292



TORTUGA 272



VESPER 278



MANDARINAS 295



MOUSSE 48



REW 82

## Accesorios Accessories

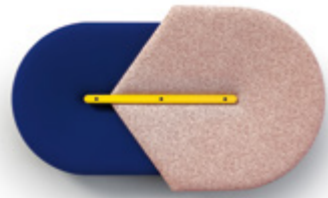

BEETLE 254



FLOAT 302



TALO 296



PARTY 296



TECNO 296

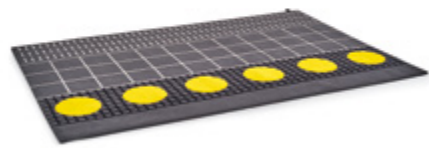

MIND THE GAP 298



PERIGALLO 248

## Cojines Cushions



ALPINO 26



BANG! 294

## Cosas Lifestyle products

Sancal Cosas es nuestra gama de productos lifestyle. ¡Verás la vidilla que da a este catálogo!

Sancal Cosas is our range of lifestyle products that livens up this catalogue.

+ info. [www.sancal.com/cosas](http://www.sancal.com/cosas)



COSAS 303

# Sofás

# Sofas



# ALPINO

**Conexión Natural.** Rafa García a menudo se aventura con su bici por bosques y montañas, lugar en el que se ha inspirado para su nueva creación, **Alpino**.

Los suaves picos de las almohadas y la base de los respaldos se solapan entre sí para simular un perfil montañoso.

Especialmente concebido para uso doméstico, el diseñador crea un reconfortante refugio para la intimidad del hogar. La altura del respaldo es uno de los elementos a destacar, pues recoge de manera natural la cabeza.

Un diseño de apariencia serena y sencilla, no carente de complejidad constructiva por la peculiar forma de los brazos y la delgadez de sus respaldos.

**Rafa** ha diseñado múltiples soluciones para personalizar las composiciones. Un brazo solapa que imita una manta dejada caer sobre sí mismo y un brazo recto. Cuatro tipos de puf con diferentes funciones: integrado dentro de la composición como un asiento sin respaldo, como ángulo para crear rincones, como terminal o, simplemente, como puf independiente. La modulación se completa con una chaise y un ángulo recto.

**Alpino** amplía las opciones de personalización al tapizarse con todas las colecciones textiles disponibles en nuestro catálogo, y sus esbeltas patas de roble están disponibles en todos los colores de nuestra carta de tintes.

**A Natural Connection.** Rafa García is a keen mountain biker and found inspiration for his latest piece, **Alpino**, when he was out and about.

The soft peaks of the base and back cushions overlap, just like a mountain range.

The designer has created a cosy refuge for home. The backrest nestles your head in a comfortable position; ideal for binge-watching, reading or dozing off after a walk in the countryside.

A serene and simple design, not without constructive complexity due to its unique arm shapes and the soft yet thin backrests.

**Rafa** offers multiple solutions to personalise the compositions. An arm with a flap, reminiscent of a draped blanket. Four different types of pouf are available that can be integrated inside the composition as a seat without backrest, create corners, be used as a terminal element or simply as an independent ottoman. A range of modules can be slotted together including a chaise and angle element.

Sanca's extensive textile collection provides the **Alpino** with another layer of personalization and its slender oak legs can be lacquered in a wealth of colours.

ALPINO by Rafa García, 2019















# NEXT STOP

**Next Stop** es un completo programa de asientos desarrollado en colaboración con **Luca Nichetto**. Para su diseño, toma prestada la racional disposición de los asientos de un vagón y la simetría de las luminarias de la línea M3 y da como resultado una amplia familia con múltiples disposiciones.

El innovador sistema de tapizado aumenta el valor de **Next Stop**, pues está disponible en un tejido de punto exclusivo cuya confección ha sido desarrollada específicamente para este proyecto en colaboración con la **Marie-Louise Rosholm**. El tejido **Zero** usa la más sofisticada tecnología para confeccionar un traje a medida y generar cero residuos. En cuanto al colorido, **Zero** cambia de dígito y da lugar a cinco combinaciones bi-color.

La modularidad de **Next Stop** se basa en un esquema de plazas de asiento compuesto por tres almohadillas unidas por una funda textil, que sirve de medida para definir sillones, sofás y módulos. Cualquiera de ellos puede incorporar brazos o mesitas auxiliares de diversas medidas. Además, a cualquier pieza se le puede añadir una mesa central, terminal o de ángulo.

La estructura metálica que sustenta el conjunto es de acero y está disponible en epoxi negro texturizado o cromado. La base del asiento y el respaldo, así como las mesitas están elaboradas en tablero marino chapado en fresno y disponibles en todos sus acabados, o en tablero marino chapado en nogal acabado natural.

**Next Stop** ha sido concebido para embellecer con singular discreción zonas de espera, espacios de trabajo o áreas multifuncionales. Un diseño con carácter social que enaltece la función de los bancos que se encuentran en las estaciones de metro.

**The ability to wait.** **Next Stop** is the firm's new soft seating system developed in collaboration with the renowned designer **Luca Nichetto**. He took the symmetry of train seats and the M3's lighting as inspiration for the seat and back cushions. The result is an endless modular seating programme.

**Next Stop** features a revolutionary fabric **Zero**, designed specifically for the product in collaboration with **Marie-Louise Rosholm**. The woollen textile uses the most sophisticated technology to make a tailor-made suit that virtually eliminates seams and waste. There are five bi-colour options to choose from that remind us of a knitted jersey.

**Next Stop** is based on a scheme of cushions made of three seating pads in a textile cover, multiples of which are used to create longer or shorter bench-like seats. Arms can be added to make two and three seaters sofa as well as armchairs. Two sizes of pouf and additional tables can be attached in the centre, end, or corner.

The steel structure is available in a black or chrome, textured epoxy coating. The table, seat and backrest marine board's veneer is available in ash, which can be stained as per our colour chart, or natural walnut.

This range has been conceived to add a touch of sophistication to lobbies, waiting rooms and breakout areas, reminding us of the function of a humble bench at the metro station.



Sofá, sofa

**ZERO TEXTILE**  
By Marie-Louise Rosholm



NEXT STOP by Nichetto Studio, 2019

**OTHER FABRICS**















# MOUSSE

**Placer multisensorial.** Rafa García se ha colgado el mandil de repostero para ofrecernos una de sus recetas más dulces, **Mousse**, un amplio programa modular de asientos.

Purista en sus formas y de equilibradas proporciones, a la vista queda patente su dulce carácter gracias a sus suaves volúmenes, marcando un cariz atemporal más allá de modas efímeras.

Su sentada, de esponjoso y mullido tacto, es su rasgo distintivo pues emula esa textura de diminutas burbujas tan característica del popular postre. Además, al igual que él aparenta un compacto bloque que se desvanece tan pronto lo pruebas. **Mousse** es una invitación a dejarse llevar, transformando la acción de sentarse en toda una experiencia. Sus almohadas accesorias ayudan a potenciar esta sensación.

Otro aspecto que lo hace singular es la gran modularidad disponible. Las 2 tipologías de módulos y chaises sumadas a las dos alturas de brazos, los numerosos pufs y los distintos terminales, dan como resultado una infinidad de posibilidades que permiten configurar composiciones lineales o angulares casi únicas, adaptándose a las necesidades de cada espacio.

Las patas suscriben la simplicidad formal del modelo, mientras que el hecho de poder lacarlas en cualquier color de nuestro muestrario aporta un extra de personalización. **Mousse** introduce también una mesita auxiliar y 3 tamaños de bandeja con 2 alturas distintas, que permiten ser colocados sobre cualquier elemento (brazo, respaldo o asiento). Un nuevo acabado denominado "craquelé" va a convertir en centro de atención las tapas de estos accesorios.

**A pleasure for all five senses.** Rafa García has put on his apron to offer us one of his sweetest recipes, **Mousse**, a wide ranging seating system.

Purist in its forms and balanced proportions, the sweet character is expressed through supple visual cues. A timeless look beyond ephemeral fashions.

The seat, fluffy and soft, emulates the texture of air bubbles so characteristic of the popular dessert. **Mousse** is an invitation to let go and be caught, transforming the action of sitting into an experience. The snug fibre and foam interior cocoons us and absorbs the din of contemporary living, much to the relief of our ears. The scatter cushions help to enhance this feeling.

Another aspect that makes **Mousse** unique is the varied array of modular elements available. Two types of modules and chaises with two arm heights, along with different poufs and terminals, offer unlimited possibilities to configure linear or angular compositions. This, coupled with an extensive selection of fabrics, means that **Mousse** can fit into a wide range of interiors.

The accessories and details add identity to this model, **Mousse** includes an auxiliary table with three tray sizes and two different heights, which can be placed on any element (arm, back or seat). A new finish called "craquelé" helps to set these pieces apart. The innovative foot design can be lacquered in any colour, providing extra personalisation.

MOUSSE by Rafa García, 2018



Sofá, sofa









# DB

¡Una joya por descubrir! DB es el acrónimo de “diamante en bruto”, apelativo con el que **Elena y Esther Castaño** han bromeado durante años cada vez que se acomodaban en un viejo prototipo diseñado por su padre. Cada verano, el enorme y confortable sillón las envolvía en tardes de lectura o de siesta y siempre decían: *“¡no entendemos porque no salió al mercado! Con algunos pequeños retoques encajaría perfectamente en el catálogo de Sancal. Es un diamante en bruto que está por pulir...”*

Dicho y hecho. Tras un ligero reestiling y una actualización de materiales, **DB** está listo para que cualquiera pueda disfrutar de él.

Sus diagonales y ángulos facetados, aplicados incluso a las patas, nos recuerdan a la codiciada piedra. Por otra parte, su aspecto es rotundo, así que el apellido “bruto” le viene al pelo.

A jewel to be discovered! DB is the Spanish acronym for “Diamante en Bruto” (rough diamond). **Elena and Esther Castaño** have joked about this nickname for years, every time they settled into an old prototype designed by her father. Every summer, the huge, comfortable armchair wrapped around them while reading or taking a nap. They always said: “We don’t understand why it wasn’t presented in society! With some small tweaks, it would fit perfectly into Sancal’s catalogue. It’s a rough diamond to be polished ...”

So, after a slight re-styling and upgrade, **DB** is ready to be enjoyed by anyone.

Its diagonal and faceted angles, even applied to the legs, remind us of the precious stone. On the other hand, its stern lines lend themselves to the product’s “rough” surname.



DB by [Santiago Castaño](#), 2018



Sofá, sofa







# DEEP

**Sumérgete en las profundidades...** Deep es un programa modular de **Rafa García**. Se trata de un diseño racional y clásico. Máxima comodidad con el mínimo artificio. Con este diseño, **Rafa** refuerza la contemporaneidad de nuestro catálogo y demuestra que la sencillez no está reñida con el lujo.

Exteriormente la estructura de **Deep** es como una caja, el respaldo se une a los brazos remarcando ángulos y líneas rectas. En el interior en cambio la superficie es curva para potenciar el confort. El perfil del asiento tiene un diseño biselado para hacerlo casi desaparecer. Las bandas de las almohadas insisten en el racionalismo más clásico, y la separación entre las almohadas de respaldo deja espacio para vislumbrar la ya mencionada suavidad interior de la estructura. **Deep** también se caracteriza por una gran modularidad capaz de adaptarse a todos los espacios.

Los cojines auxiliares ayudan a personalizar nuestro sofá, y lo adaptan a las necesidades de ergonomía y estética de cada usuario. Gracias a la profundidad del asiento, podremos añadir una amplia combinación de almohadones y así, combinar los cojines acolchados para los brazos, con las almohadas lumbares y los cojines-estola (con textiles de Paul Smith) para el cabezal, hasta conseguir un **Deep** único, hecho a nuestra medida.

Vistas de frente, las patas no son más que un sutil y delgado perfil, pero desde el lateral, cobran importancia y muestran su marcado carácter. Son de aluminio y están disponibles en un amplio colorido: oro y carbón (anodizado mate) y en todos los colores de nuestra carta de lacados.

**Dive down to the depths ...** Deep is a modular seating system by **Rafa García** for **Sancal**. A rational design studied to provide uncompromised comfort with the smallest footprint possible. With this design, Rafa reinforces the contemporary side of **Sancal's** catalogue and demonstrates that simplicity need not be the opposite of luxury.

The box-like exterior with its strict angles and straight lines gives way to a bulbous interior. The seat structure is bevelled to such a degree that it seems to disappear while still providing support and strength. The cushion boxing is a nod to classical rationalism with a separation that enables the padded structure to be seen. **Deep** is one of the firm's most adaptable products. A varied array of modular elements means that it can fit into a wide range of interiors.

The cushion accessories can also be used to personalise the sofa, adapting to the ergonomic and aesthetic necessities of each user. Ample scatter cushions can be added to vary the deepness of the seat. Quilted arm cushions can be combined with lumbar supports and stole-like headrest cushions (with fabrics by Paul Smith) to create an infinite array of unique **Deep**s.

From a front elevation, the feet are subtle and fine, but from the side they reveal their importance. Made of aluminium, they are available in a wide range of colours: gold or carbon (anodized matte) and all the colours in the lacquer chart.



DEEP by Rafa García, 2017







# OBI

**El descanso de las geishas y los samuráis contemporáneos.** Inspirado en la esponjosidad de los lazos de los kimonos (obis en japonés), el diseño de **Rafa García** para **Sancal** es un "sofá-colchón" extraconfortable. La altura del respaldo y la curvatura de sus brazos abrazan a quien se aposenta en sus mullidas almohadas. El acolchado textil refuerza esta sensación de suavidad.

Para aligerar el diseño, **Rafa** ha proyectado unas sencillas y esbeltas patas (transparentes o de fresno tintado) que lo elevan considerablemente del suelo. En la versión de metacrilato esta sensación áerea es mucho más evidente. **Obi** es tan cómodo como práctico. Gracias a su extensa modulación es posible hacer multitud de configuraciones. Destacamos los ángulos largos para hacer estilizadas composiciones de rincón y la chaise de 134cm con la que configurar un sofá con más fondo.

**Rest like modern-day geishas or samurai.** Inspired by the quilted kimono bows (obis in Japanese), this design by **Rafa García** for **Sancal** is an extraordinarily comfortable mattress-like sofa. The back height and curved arms beckon you sink into a soft, quilted seat. To make the design feel lighter, **Rafa** has created some unique feet, available in ash, or, to really give a sensation of antigravity, transparent acrylic.

**Obi** is as practical as it is comfortable. It features an extensive array of different modules, including long angled pieces to make corner sofas and a 134cm chaise longue for extra depth.



OBI by Rafa García, 2016







# TONELLA

**Del tocador al mundo entero.** Sancal comenzó su andadura empresarial fabricando butaquitas clásicas de estilo francés. Cuatro décadas más tarde, decidimos rendir homenaje a nuestros inicios desde un punto de vista contemporáneo. El estudio sueco **Note** reinterpretó hábilmente nuestra vieja María Antonieta. Tras el éxito de esta pequeña butaquita de tocador, **Note** propuso aumentar la familia **Tonella**; sillón, sofá puf y taburete.

Continuando con el tonel como inspiración **Note** ha proyectado un sillón y un sofá de mayor tamaño con una sentada más relajada. El tapizado de las almohadas interiores es liso mientras que la parte exterior del respaldo es acolchado con un dibujo de líneas verticales para simular que las duelas del tonel trepan por la estructura.

**A trip around the world that started at a vanity table.** Sancal started out manufacturing classic, French-style chairs. Four decades on, we have decided to revisit our origins and borrow from the past. The **Swedish design Studio Note** cleverly reinterpreted our Marie Antoinette-style vanity chair last year. After receiving an excellent reception, **Note** have added new members to the **Tonella** family: sofa, armchair, pouf and stool.

**Spanish** wine barrels remain the inspiration for the new, larger sofa and armchair. The straight line quilting runs down the outside of the piece, like staves, contrasting with the smooth interior cushions. The Marie Antoinette-style seat, back and arms are made from moulded polyurethane foam. The plain interior area can be upholstered in fabric or leather; however the outer quilting is only available in fabric.



Sofá, sofa







# TIPTOE

**Placer y relajación.** Estéticamente sobrio y racional, **Tiptoe** ha sido concebido para actualizar la imagen de un clásico contemporáneo. Su funcionalidad y sencillez armonizan con un amplio abanico de estilos y permiten crear entornos serenos y calmados. Las esbeltas patas que inspiran el nombre del modelo, nos hacen imaginar una colección sigilosa, sutil, ligera e integradora, como quien "camina de puntillas" para no molestar. Además de realzar el diseño, las patas le aportan sofisticación en cualquiera de las dos versiones disponibles: cobre y grafito.

**Tiptoe** es también un sofá confortable e irresistiblemente hogareño. Su fondo reducido y la variedad de medidas para módulos y brazos, así como el gran número de piezas creadas para adaptarse a necesidades reales, acentúan el enfoque doméstico. La mezcla de fibra y viscoelástica de sus almohadas proporciona una sentada placentera. Las composiciones con chaises longues son perfectas para inundarlas de cojines.

**The pleasure of relaxation.** With clean, rational lines, **Tiptoe** takes contemporary pieces one step forward. A design based on a philosophy of simplicity and functionality, it is a sofa that can be used with different styles to create calm, serene environments. The slim legs give the piece its name, a model that is quiet, subtle, light and nimble, as if it were tip-toeing around the living room. As well as setting off the design, the legs provide a sophisticated touch in either of their finishes: copper or anthracite.

**Tiptoe** is irresistibly cosy. Its studied depth, variety of modules and various types of arm, means that it can be configured to fit into any home. The use of fibre and memory foam in its cushions makes this one of our most comfortable products. Wallow in scatter cushions by adding extra deep modules or a chaise longue.



TIPTOE by [Rafa García](#), 2015





# REW

**Es el acrónimo de rest-eat-work** (descansar-comer-trabajar). El significado literal de esas palabras define a la perfección la funcionalidad del programa de asientos **REW**.

**Rest.** El descanso lo proporciona una familia de sillones, sofás y módulos tan ligeros como confortables en los que podremos elegir entre tres alturas de respaldo (L, XL, XXL) dos diseños diferentes para los brazos: uno tan alto y delgado como los respaldos y otro más bajo y mullido como la base del asiento.

**Eat.** La parte "nutritiva" se corresponde con un amplio abanico de bancos y bancadas para acompañar todo tipo de mesas de comedor. Los bancos pueden ir solos o en compañía de paneles de pared tapizados. Las bancadas están disponibles con dos fondos (57 y 72 cm). El fondo más corto encaja con el prototipo tradicional de bancada y proporciona una sentada más firme y recta. Además, la terminación en esquina de los brazos altos permite realizar composiciones con ángulos rectos. El fondo más largo tiene una medida ideal para llenarlo de cojines de decoración y generar una sentada más informal,

perfecta para largas sobremesas. Asimismo, para las bancadas **Rafa** propone dos alturas de respaldo (L y XL). El respaldo bajo potencia la ligereza del diseño. Los respaldos altos proporcionan intimidad.

**Work.** La productividad en el trabajo está directamente relacionada con nuestra concentración y bienestar. La versión de sillones, sofás y módulos con respaldo alto permite gozar de cierto aislamiento en medio de una gran oficina o en el hall del hotel. **Rafa** también ha diseñado dos cojines para completar el programa.

Las patas son de acero lacado negro y madera de fresno, la cual se puede solicitar en todos los colores de nuestra carta de tintes.

**An acronym for rest-eat-work.** This creation by **Rafa García** is tremendously versatile, and can be used for a variety of diverse projects that require pieces for resting, eating or working.

**Rest.** An entire family of chairs, sofas and modules, as light as they are comfortable, can be used with two different types of arm: one is high and thin like the

backs and the other is low and soft, like the base of the design.

**Eat.** The "nutritious" part corresponds to an ample number of benches which can be used with a dining table. The benches can be used alone, or together with upholstered wall pieces. The benches are available in two depths (shallow and deep). The least deep is the archetypal dining bench, providing a firm, upright sitting position. Moreover, the finish of the arms in a corner permits compositions with angles to be made. The deeper version is ideal to fill with scatter cushions and create an informal environment, perfect for long postprandial conversations. **Rafa's** piece provides two back heights, L and XL. The low back creates a light design, while the higher backs provide some privacy.

**Work.** The productivity at work is directly related to our concentration and feeling of wellbeing. These versions of the sofas, modules, and chairs enable a certain degree of privacy in an office setting, or the hall of a hotel. **Rafa** has also designed a bench and a couple of cushions to complete the programme.

The feet are available in steel lacquered black, or ash, which can be stained to any of the colours in our collection.



REW by Rafa García, 2014



Sofá, sofa









# BARNABY

**Sofisticando la tradicional sábana cubre-sofás.**

**Perrine Vigneron & Gilles Belley** dan una vuelta de tuerca a un viejo recuerdo de la infancia: las sábanas que nuestras abuelas ponían encima del sofá para protegerlo de nuestras "pezuñas". Esta antigua costumbre forma parte de la tradición popular mediterránea, así que nos pareció todo un acierto trabajar en ella desde un punto de vista contemporáneo. De este "experimento" surge el dúo de sofás y sillones **Barnaby**.

Tras un arduo trabajo de patronaje conseguimos que el textil que recubre la estructura se pueda acolchar respetando las proporciones exactas de cada uno de sus volúmenes. Al tratarse de una funda suelta, **Barnaby** puede enfundarse y desenfundarse fácilmente y permite disponer de fundas adicionales para cambiar rápidamente de look según las necesidades del momento. Las cintas laterales dan color y remarcan las esculturales formas del diseño.

**Taking the tradition of sofa throws to the next level.**

**Perrine Vigneron & Gilles Belley** have transformed the anti-aesthetic practice of covering a sofa with a cover into a work of art. This tradition was particularly prevalent on Spain's Mediterranean coast and was crying out to be updated. From this experiment, a duo of sofas and chairs were born.

After a seemingly infinite amount of prototypes, we managed to cover the structure whilst respecting the volumes. As the cover is loose, it can be easily changed to create a new look. The coloured taping adds a touch of colour and marks the lines of the piece.

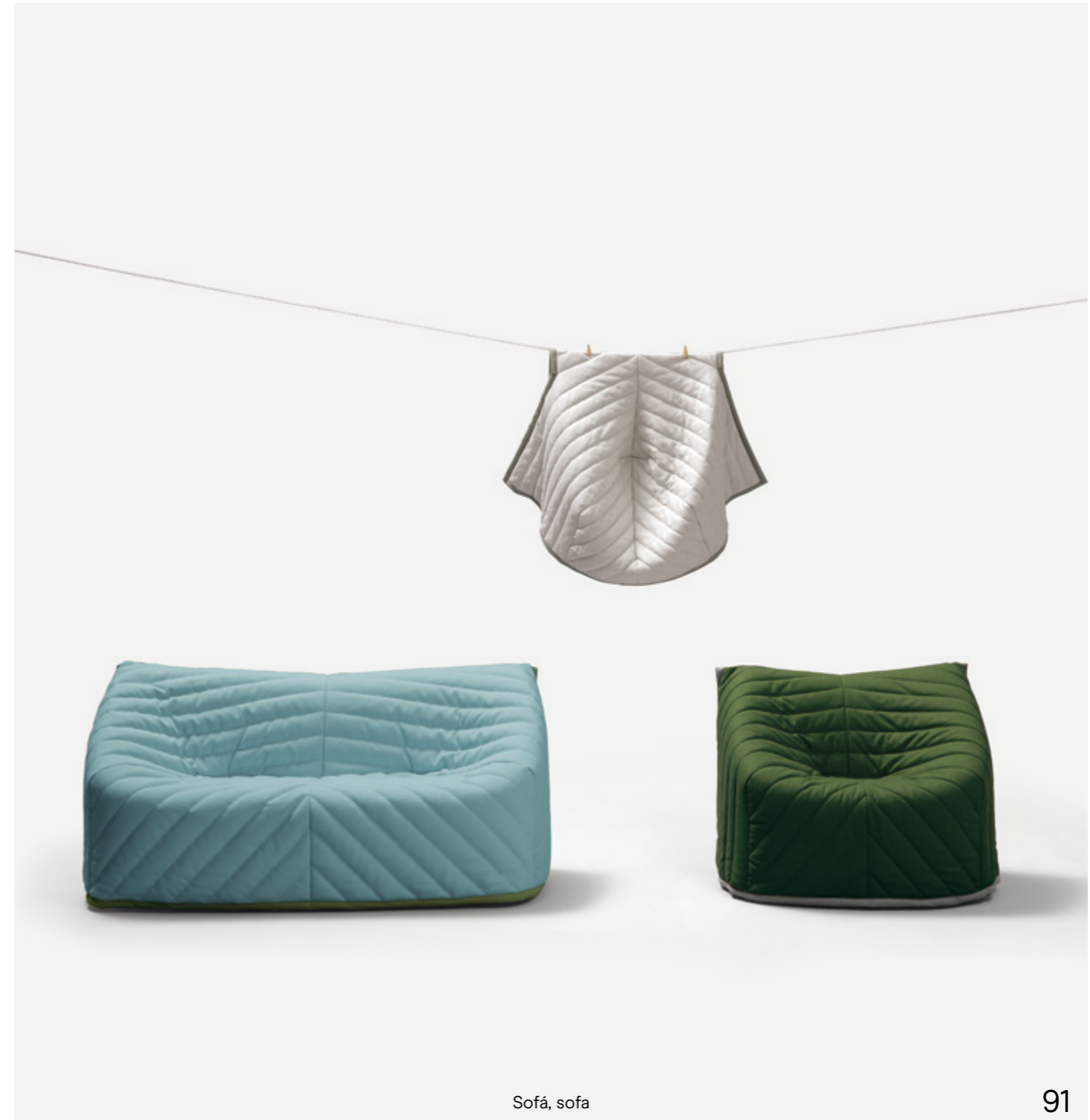

Sofá, sofa





Sofá, sofa

# SUMO

**Perfiladas curvas para el canal contract.** Yonoh presenta un dúo de sofá y sillón con un toque japonés. El concepto, como su nombre indica, parte de la robusta fisonomía de los luchadores de sumo y contrasta con la ligereza de la base, inspirada en los zuecos que los transportan fuera del ring.

La madera elegida para "calzar" la colección es fresno por su riqueza en vetas y su porosidad. Las opciones de tinte van desde colores muy naturales hasta los más artificiales como el rosa o el amarillo. Destaca la peculiar forma de costura que rodea todo el perímetro exterior del asiento.

**Clara y Alex** trascienden el arquetipo de asiento para espacios públicos suavizando las formas. A pesar de su oronda presencia, **Sumo** ocupa un espacio muy reducido gracias a sus compactas dimensiones (178 y 92 centímetros para el sofá y el sillón respectivamente).

**Pronounced curves for the contract market.** Yonoh presents a sofa and armchair with a Japanese touch. The concept, as its name suggests, takes its inspiration from the powerful silhouette of sumo wrestlers, contrasted with the light wooden clogs that they use to and from the ring (dohyō).

The wood chosen for the collection is ash, due to its texture and grain. A wide array of stains is available: from natural shades to vibrant colours like pink or yellow. The raised seams help to define the curved lines of the piece.

**Clara and Alex** have defied the tenets of box-like shapes being used for public areas by using softer forms. Yet, despite its hefty appearance, Sumo has a small footprint (178cm and 92cm for the sofa and armchair respectively).





# COPLA

**El más mullido y castizo.** Las torneadas patas de madera de fresno de este mullido sofá inspiran el nombre de un diseño que homenajea los antiguos cafés cantante. De **Copla** también destacamos la suavidad de sus formas y sus ahuecadas almohadas.

**Copla** es un sofá modular pensado para dotar de calidez y verdadero confort espacios públicos de toda índole. Gracias al aspecto desenfadado sus almohadas, consigue diferenciarse de la rigidez típica del mobiliario para colectividades. Este suave toque hace que **Copla** no quede excluido de entornos más hogareños.

Dos tipos de brazo, 3 sillones, 12 sofás, 9 módulos diferentes y 1 ángulo, permiten componer una melodía a la medida de cada proyecto. **Rafa García** recomienda crear las composiciones angulares con cualquiera de las piezas de brazo alto, aunque también existe el ángulo recto.

**Autentic and shapely.** Shapely ash legs, and plump cushions, pays homage to the songbirds of Spain's traditional café theatres performing their "**Coplas**".

**Copla** is a welcome, inviting piece both at home and in public spaces. The casual, cosy look of its cushions and striking, 21cm tall, leg structure set the piece apart from the pack. For added impact, choose a wood stain from our selection of vibrant or natural colours.

The composition's generous array of elements, two different arms, three armchairs, twelve sofas, nine modules and a corner module, enable the design to be arranged to the needs of each project. The best way to create angle combinations is to simply use any of the high arm pieces, although there is also a dedicated corner module if required.



COPLA by Rafa García, 2012



Sofá, sofa



# FOLK

**Más es mejor.** Gracias a la suavidad de sus almohadas, las proporciones del respaldo y su altura, hemos conseguido crear una sentada que te abraza y te permite recostar la cabeza sin necesidad de recurrir a ningún mecanismo.

Para aunar bienestar y durabilidad, las almohadas de asiento combinan distintas densidades de espuma con una capa externa de Fiberdream (micro-fibra tacto pluma). Las almohadas de respaldo son ultra-soft. La colección está compuesta por sofás y módulos con y sin oreja. Las orejas dan carácter al diseño y potencian su comodidad. Para los respaldos y los pufs **Rafa García** ha creado una funda opcional con un delicado acolchado que podemos incorporar a cualquier pieza.

Las patas, de madera de haya, están disponibles en natural, nogal, antracita o wengué plus.

**More is better.** Thanks to the softness of the cushions, the proportions of the back and its height, we managed to create a sofa that hugs you and lets you lay your head on the backrest, without the need for a mechanism.

In order to unite comfort with durability, the seat cushions combine various densities of foam with a layer of Fiberdream (down-like microfibre). The back cushions are ultra-soft. The entire collection consists of sofas and modules with and without wings. The wings give personality to this design and enhance its comfort. For backs and poufs, **Rafa García** has created an optional quilted cover.

The beech feet are available in natural, walnut, anthracite or wengue plus.



FOLK by Rafa García, 2011







# FLOAT

Un sofá que hace las veces de biombo. De la mano de **Karim Rashid** hemos conseguido crear un asiento que respeta nuestro universo propio cuando habitamos espacios públicos. **Float** es un diván contemporáneo pensado para múltiples usos. Este delgado asiento flotante, con pared incorporada, nos concede total privacidad en entornos abiertos para recostarnos, colgar la bufanda y el abrigo, o simplemente esperar en el reservado que dispone su enorme respaldo.

**Float** está disponible en tres tamaños: dos sofás con respaldo bajo y un sofá con respaldo alto. Este último tiene distintas configuraciones; además de los brazos rectos, podemos seleccionar un brazo inclinado que sirve para recostarnos sobre él a modo de diván. Asimismo, el respaldo alto, como si de una pared se tratara, permite incorporar dos colgadores. Para cojines y reposacabezas **Karim** también ha diseñado una serie de estampados denominados **Cairo**.

**A sofa that is also a screen.** Hand in hand with **Karim Rashid**, we have created a contemporary couch that is ideal for a range of projects. The back doubles as a wall-like screen that provides an oasis of personal space – we can even hang our scarf or coat on a hook while we are waiting. The headrest, cushions and arms are all available in different fabrics, adding an element of fun to any area.

The **Float** is available in three sizes: two sofas with a low back and one sofa with a high back, so the product will fit a range of applications. The latter can be configured to include straight arms or a reclining version to lie back on like a divan, as well as the option of fitting coat hooks. **Karim** has even designed a special fabric called **Cairo** to use on the headrests and scatter cushions.

FLOAT by Karim Rashid, 2012



Sofá, sofa





# TEA

**Tea** es la consecuencia de reclamar a un placer estético que se percibe por la vista y el tacto; de una intensa búsqueda para despertar emociones en el usuario. Para ello **Sancal** ha contado con **Estudi(H)ac de José Manuel Ferrero**, quien ha proyectado una colección de asientos inspirada en el momento del té. **Estudi(H)ac** propone combinar texturas y materiales al más puro estilo british.

El acolchado hexagonal y las opciones bicolor son los elementos clave este clásico revisado, actual y desenfadado, pero siempre elegante y distinguido.

Let the **Tea** envelope you in its soft quilting and irresistible lines. The design studio **Estudi(H)ac**, headed by **Jose Manuel Ferrero**, cites the ritual of teatime as their inspiration. With exquisite materials and careful execution, the piece exudes British style.

A hexagonal quilted pattern and two-tone effects give the elegant design a casual, contemporary twist.



TEA by **Estudi(H)ac**, 2010



Sofá, sofa





# HAPPEN

**Happen** nace con el propósito de ser normal, concebido para ir más allá de modas pasajeras. Buscando formas atemporales para trascender. **Rafa García**, no ha intentado reinventar nada, sólo practicar el diseño teniendo muy en cuenta las proporciones, los materiales, las costuras y la capacidad de crear composiciones dinámicas; siempre con el convencimiento de que cada detalle, por pequeño que sea, es importante.

**Happen** propone una fina base con forma de L en la cual ir integrando elementos. Más que un puzzle, se trata de un extenso programa modular, más próximo al sistema de componibles del mueble que al de la tapicería.

**Happen** is a timeless piece that rises above transient fads. **Rafa García** was not aiming to reinvent the sofa, but to refine it, obsessing over the smallest details of its proportions, materials and seams.

This seemingly straight-forward design uses an ingenious L shaped base to integrate the different elements. The result is our widest selection of modules, a programme more akin to cabinets than upholstery.



HAPPEN by [Rafa García](#), 2010



Sofá, sofa





# CITY

**City** es un proyecto urbano y dinámico que nos permite personalizar cada composición a partir de un único diseño para la estructura y diferentes propuestas para respaldos, asientos y patas. Estas variantes dan lugar a dos colecciones: **Soft** y **Casual**.

**City Soft:** cada módulo lleva incorporada unas suaves almohadas de respaldo. El resultado es un modular predefinido y pensado principalmente para el hogar.

**City Casual:** a diferencia de la colección Soft, las almohadas de respaldo no están predeterminadas. La idea es deconstruir el concepto respaldo y aligerarlo con composiciones más libres. Los respaldos de la colección Casual son totalmente customizables, es decir, podemos elegir las almohadas y cojines que nos apetezca.

Cualquiera de estas propuestas puede llevar las patas en acero inoxidable o en madera. Las patas en madera tienen 3.5 cm. de altura y bajan la sentada a 38 cm. del suelo. Las patas en acero inoxidable tienen 9.5 cm. de altura y elevan la sentada a 44 cm. del suelo.

**City** is a dynamic project that allows us to personalise each composition from only one design for the structure, but with different backs, seats and legs. These variations create two collections: **Soft** and **Casual**.

**City Soft:** module incorporates some pre-defined soft back cushions. The result is a modular design conceived for the home.

**City Casual:** in contrast to the Soft collection, the back cushions are not pre-defined. The idea is to deconstruct the back concept and to lighten up the design the backs of this Casual collection can be customized, as many cushions can be chosen as desired.

Any of these models can have stainless steel or wooden legs. The wooden legs are 3.5 cm high and bring the seating down to 38 cm from the floor. The stainless steel legs are 9.5 cm high and make the seat 44 cm from the floor.

CITY by [Rafa García](#), 2008



City Soft



City Casual

CITY SOFT



CITY CASUAL by Rafa García, 2008









# AIR

La principal característica de **Air** es la multitud de composiciones que podemos realizar a partir de sencillas variaciones en el fondo y la altura de las piezas que componen la colección. Es posible elegir indistintamente respaldos de 81 o de 88 cm. de altura. Amplían las prestaciones los tres diseños proyectados para los brazos y el resto de complementos: mesas tapizadas, pufs y almohadones extra.

Las opciones para los brazos son: ancho, estrecho y alto; y las podemos combinar en una misma pieza. El brazo alto es idóneo para formar rincón. Las patas quedan ocultas para conseguir un diseño ligero, capaz de flotar en el aire.

The main characteristic of **Air** is the multiple compositions that we can attain with simple variations of depth and height. It is possible to choose backs of 81 or 88 cm in height. The three different designs of the arms and the rest of the complements offer further possibilities: upholstered tables, poufs and extra cushions.

The arm options are: wide, narrow and high; and they can be combined within the same composition. The high arm option is perfect for forming a corner module. The beech feet are recessed: it seems to float on air!







# ELEVA

**Eleva** es un diseño sobrio y depurado, con una sentada extra-confortable de máxima calidad. Como su nombre indica, este modelo también se caracteriza por la posibilidad de incorporar un mecanismo que eleva la almohada de respaldo gradualmente hasta 9 cm.

Para subir el respaldo sólo hay que tirar del asa del mismo por la parte posterior y para devolverlo a su estado original solo es preciso tirar hacia arriba hasta liberar el mecanismo. **Eleva**, al igual que la mayoría de los productos de **Sancal**, es totalmente modular. En las composiciones con mecanismo, **Rafa García** recomienda concluir la modulación con brazos en ambos lados.

**Eleva** is a pure, sober design with high quality extra-comfortable seat. As indicated by its Spanish name, this model is also characterised by the possibility of incorporating a mechanism which allows the back cushion to lift by up to 9 cm.

In order to lift the back, you only need to pull up the handle on the rear of the cushion, and lift it again to release the mechanism. As with many of **Sancal's** sofas, the **Eleva** boasts an array of modules. In configurations that include a mechanism, **Rafa García** recommends using arms on both ends.



Sofá, sofa



# DUO

Volúmenes suaves a ras de suelo para crear un efecto chillout. Las líneas de **Duo** han sido perfiladas hasta conseguir un diseño depurado. El reto era proponer un modular de acogedora sentada sin almohadas. Misión cumplida al integrar, primero, y esculpir, después, las almohadas de asiento y respaldo en la estructura.

La amplia sentada de **Duo** permite jugar con cojines de decoración e, incluso, incorporar almohadones de respaldo extra. La variedad de módulos y terminales que ofrece este modelo lo hace polivalente para todo tipo de ambientes.

Rounded volume at floor level gives **Duo** a chill-out effect. The **Duo's** lines have been shaped to get an accentuated design. The challenge was to propose a modular system with welcoming seats, without the use of cushions. That mission was fulfilled when firstly we integrated, and then sculpted, the seat and back cushions into the structure.

The wide seat of Duo allows us to add decorative cushions and even to incorporate extra back cushions. The variety of modules and terminal modules that this model offers make it an all-purpose item for various environments.





# MOON

Al ADN 100% modular de **Moon** le podemos pedir la Luna. **Rafa García** propone partir de tres versiones para los brazos, cinco para los módulos, un puf, un ángulo y un característico sistema de unión, las combinaciones son infinitas. Pieza a pieza podemos conquistar el espacio y reconstruirlo, por ello este diseño resulta ideal para cualquier proyecto de contract.

**Moon** is a 100% modular design **Rafa García** has created three arms, five modules, one pouf, one angle and a characteristic joining system, with combinations. Piece by piece, we can conquer any space.



Sofá, sofa





# NOSSO

La Cubitera ha apostado por un diseño liviano que se integre sigilosamente en cualquier lugar y que perdure en el tiempo. Además del perfil aéreo de su estructura, el distintivo que hace de **Nosso** un diseño inconfundible es el sutil quiebro que une el asiento con los brazos.

La Cubitera has designed a lightweight sofa which blends cunningly into any place and which will remain timeless. Apart from the light profile of the structure, the subtle turn which joins the seat with the arm, makes the **Nosso** unmistakable.



NOSSO by La Cubitera, 2009



Sofá, sofa



# NAP

¡Buenas noches! **Nap** es un sofá cama de **Rafa García**. Los detalles acolchados del textil se inspiran en los antiguos colchones de lana. En dos sencillos pasos conseguimos transformar el sofá en cama y viceversa. El cajón oculto bajo la estructura es ideal para guardar la ropa de cama y los cojines.

**Good night!** The **Nap** is a sofa bed by **Rafa García**. The quilted details are inspired by the old woollen mattresses. The sofa is converted into a bed in only two movements, and vice versa. A small compartment hidden under the structure is ideal to keep the bed clothes and cushions tidy and out of sight.



NAP by [Rafa García](#), 2014





Sillones  
Butacas  
Lounge  
Chairs  
Armchairs





# TORTUGA

**La teoría de la evolución comienza en las Galápagos...** De una tortuga admiramos su longevidad y su paso lento. Por ello, cuando **Isaac Piñeiro** aceptó el reto de proyectar un sillón que se convirtiera en una merecida recompensa, en un objeto con el que soñamos de camino a casa, no dudó en inspirarse en este singular animal.

La propuesta parte de un caparazón que nos abraza sin miedo al qué dirán, donde dar rienda suelta al mundo de las letras o al de los sueños... Su simpleza formal conecta y continúa con la filosofía tranquila del diseñador, si bien, la profusión de los textiles disponibles lo traslada a una dimensión mucho más exuberante.

Tras el éxito cosechado por sus progenitores, **Isaac** propone unas mini butaquitas súper confortables que harán las delicias de cualquier salón. Pero también son idóneas para espacios como cafeterías y habitaciones de hotel, donde la falta de espacio es condicionante. Gracias a las nuevas incorporaciones, la familia **Tortuga** se adapta mejor a todo tipo de ecosistemas. Los pufs y mesitas complementan la oferta.

**The theory of evolution started with the Galapagos tortoise.** We admire the slow, stately pace of a tortoise and envy its long life. When **Isaac Piñeiro** took on the challenge to come up with a timeless design, a chair that we could dream of as we plod back home, inspiration from this enduring animal reared its head.

The idea stems from a shell that we can withdraw into, immersing ourselves in a good novel or drifting off to sleep... Its simplicity reflects the tranquility of **Isaac's** ethos, although the choice of textiles can add contrasting exuberance.

After the success of its forbearers, **Isaac** proposes some comfortable mini lounge chairs that will be a delight in any space, also, they are suitable for projects like cafés and hotel rooms where space is compromised. And so, with the new additions, the **Tortuga** family adapts even better to its environment with a range of full-sized and mini lounge chairs. Poufs and side tables complete the collection.

TORTUGA by [Isaac Piñeiro](#), 2016









# MAGNUM

Inspirada en la exquisitez de Savile Row. Estudi{H}ac hace proyectos de alta costura con alto riesgo y su fundador, **José Manuel Ferrero**, es un auténtico gentleman.

Para **Ferrero** la elegancia es ante todo una actitud y los británicos saben mucho de esto; por ello la inspiración de **Magnum** nace de las copas de coñac que la alta sociedad londinense tomaba mientras discutía de política en sus exclusivos clubs.

Se trata de una familia de asientos especialmente diseñada para el sector de la hostelería, sin embargo, gracias a sus formas sinuosas, su elevado confort y reducidas dimensiones, tanto las sillas como los taburetes y butacas, pueden amueblar los hogares más singulares.

Esta polivalencia se materializa en una amplia oferta de tejidos y acabados para las bases: con patas metálicas o de madera, con base tapizada, con zócalo o pie central

Designed in the Savile Row tradition. Estudi{H}ac's José Manuel Ferrero might be Spanish, but his approach to design is akin to the bespoke tailoring of Mayfair.

His new range of soft seating for **Sancal**, the **Magnum** pays homage to this very British elegance. The gentleman designer has drawn inspiration from the glasses of cognac members of exclusive London clubs cradle in their hands as they debate politics.

Comprising stools, lounge chairs and dining chairs, the range has been designed to withstand both demanding public spaces and domestic use. Even the smallest spaces can now enjoy luxurious comfort with these compact, fully upholstered pieces.

The products can all be customised by selecting from a wide array of options. The bases can be: gold coloured plinths, lacquered metal central feet, upholstery bases or four legs.



MAGNUM by Estudi{H}ac, 2017

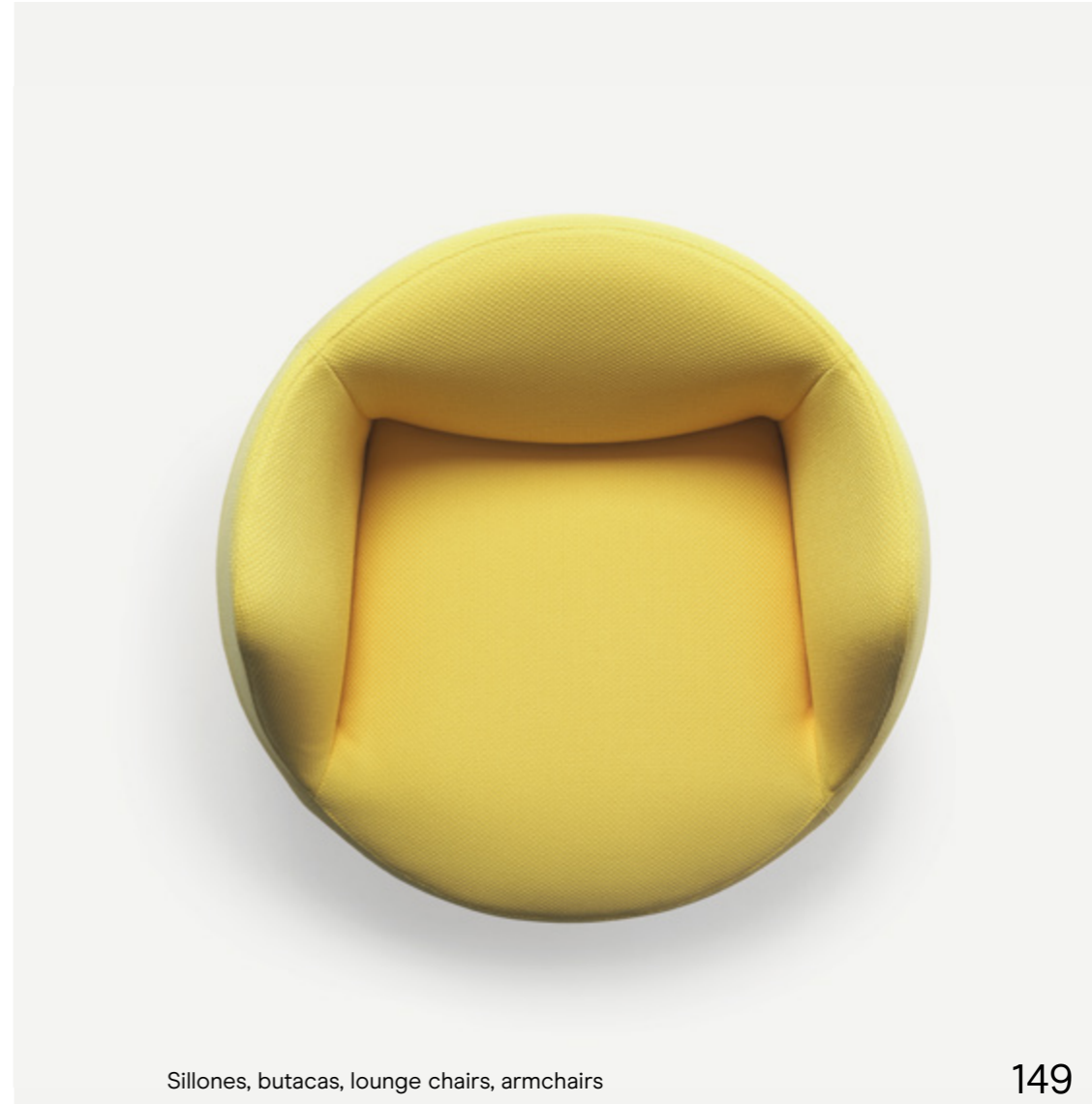

Sillones, butacas, lounge chairs, armchairs





# TONELLA

**¡Pequeñita pero matona! Sancal** comenzó su andadura empresarial fabricando butacas clásicas de estilo francés. Cuatro décadas más tarde, decidimos rendir homenaje a nuestros inicios desde un punto de vista contemporáneo. Enmarcada en la tipología “butaca de tocador”, la pequeña **Tonella** es casi un asiento de bolsillo, por lo que tiene cabida en cualquier rincón. Resulta una compañera ideal para amplios sofás de hogar, pero también puede utilizarse en espacios públicos gracias a su solidez.

El estudio sueco **Note** se ha inspirado en un tonel para recordar nuestra vieja butaquita María Antoñeta. La base está disponible en dos acabados metalizados: bronce y nácar. Sus finas varillas emulan las duelas de un barril. El asiento y respaldo está inyectado en espuma de poliuretano flexible moldeado. La parte interior es lisa y se puede tapizar en tela y piel. El acolchado de la parte exterior dibuja líneas verticales para simular que las duelas trepan por la estructura.

**Tiny but tough! Sancal** started out manufacturing classic, French-style chairs. Four decades on, we have decided to revisit our origins and borrow from the past. The Swedish design studio **Note** was selected to give the project a fresh, innovative angle. The original piece was classified as a dressing-table chair, but the tiny new **Tonella** is far more compact, designed to fit into the smallest corner. Despite its reduced size it is enormously versatile, comfortable and sturdy, making it an ideal piece to accompany a sofa at home, placed in hotel rooms, shop dressing rooms or public areas.

**Sancal** is based in Yecla, a wine-growing region in southern Spain. Barrels are commonplace, and the metallic support is reminiscent of their staves. The Marie Antoinette-style seat, back and arms are made from moulded polyurethane foam. The plain interior area can be upholstered in fabric or leather, the outer area is quilted to follow the barrel style lines of the base and is therefore only available in fabric.



TONELLA by Note, 2015

Sillones, butacas, lounge chairs, armchairs







Butaca, armchair



Silla, chair

# NIDO

El asiento o **Nido** está sustentado por una base de madera de fresno que es el resultado de un artesanal trabajo de carpintería. Como si de las ramas de árbol se tratara, la parte superior de las patas abraza y rodea el asiento. Como alternativa, **Rafa** presenta una variante con pata de metal lacado con un singular acabado rugoso de color negro mate.

El textil que recubre el asiento está disponible en dos versiones (con cremallera o con vivo). La versión con cremallera perimetral es más mullida y permite desenfundar la parte interior de la butaca. La versión con vivo es totalmente fija y con un tapizado más tenso. La parte exterior del asiento está facetada para remarcar todas sus líneas. En contraposición, la parte interior es mucho más suave, mullida y acogedora.

The seat or "nest" is supported by a hand-crafted ash wood frame or metal feet in a black-matte finish. The upper part provides "branches" into which the comfortable seat is fixed.

The upholstery is available in two versions: with a zip or with piping. The version with a zip is soft and loose and enables the seating area to be removed. However, the version with piping is fixed and pulled tight. Both the zip and piping are always in black. The back and sides of the upholstered area are tailored to show off the chair's lines whereas the seating area is soft and cosy.



Sillones, butacas, lounge chairs, armchairs



# TALO

**Una butaca con gran arraigo.** Talo es una revisión de la clásica butaca para hostelería. Sin estridencias pero con un toque distintivo y tremendamente contemporáneo, Talo aporta algo más que un extraordinario confort, lo cual la hace apta para todo tipo de ambientaciones. El sofá biplaza complementa a la butaca sin perder un ápice de comodidad.

Todos los detalles cuentan, desde el ancho vivo que rodea el perfil superior de la pieza hasta el peculiar cojín a dos niveles. El rasgo más característico de Talo lo encontramos en sus tensionadas patas (o raíces) que trepan por la estructura y resaltan por debajo del tejido.

**A small armchair with deep roots.** Talo takes a new approach to the traditional small armchair – a must-have for any hotel. Discreet and distinctive, the design is a departure from all others, yet retaining a familiar form. Talo is extraordinarily comfortable, making it the ideal piece for a range of settings.

No detail has been left to chance: from the extra thick piping that runs across the top of the piece to the special two-part cushion. However, the most characteristic element of the Talo is its feet that thrust up under the fabric, like the roots of a mangrove tree, just visible above ground level as they form the trunk.



TALO by Sebastian Herkner, 2013





# CASTA



**Música para la vista.** Estudi(H)ac presenta un sillón inspirado en uno de los instrumentos más característicos de la música popular española. El concepto fusiona las dos caras de una castañuela y el movimiento de las manos al hacerla sonar.

La funda se fija a la estructura por ambos extremos quedando el resto del tejido en el aire, a modo de hamaca. La estructura es de metal negro-mate con un singular acabado rugoso. Como contraste a esta aspereza, y para aportar calidez, los apoyabrazos se fabrican en fresno; un suave toque de madera para evocar el tacto de las castañuelas.

**Music for your eyes.** Estudi(H)ac presents an easy chair based on a castanet, one of the most emblematic Spanish instruments: the image of a lady clapping together two halves of clam-shaped wood is famous the world over. Just as two halves of clam-shaped wood are clapped together with a castanet, the armchair's characteristic cushions flap onto fabric that has been tensed over a metal structure.

The **Casta's** light structure is a radical departure from traditional thick, padded solutions for an armchair. By using fabrics that have been carefully tested by **Sancal**, even the need for elastic webbing has been eliminated. In contrast to the black matt finish of the metal structure, the smoothness of the ash armrests provides a warm contrast, evoking the feel of castanets.



CASTA by Estudi(H)ac, 2013





# BOOMERANG

Estética escandinava para una propuesta inspirada en un instrumento aborigen, el bumerán, como elemento vertebrador de todo el diseño. Limpieza y sencillez formal, vetas de madera de fresno maciza, curvas cuidadosamente mecanizadas y tacto encerado, para evidenciar la nobleza y vocación naturalista de un diseño para siempre.

La sentada casi a ras de suelo da lugar a su apellido. **Boomerang** está concebido como asiento para ambientes relajantes, chill out. Proponemos dos piezas muy características: sillón y puf.

A scandinavian look base on an aboriginal implement - the boomerang - taken as the backbone of the whole design. Clean, formal simplicity, solid ash and carefully machined curves, all showcase the noble and naturalistic crafting of a design classic.

The seat, almost at ground level, leads to the use of the adjective in **Boomerang**. The ranges offers two distinct versions: easy chair and ottoman.



BOOMERANG by Quim Larrea, 2009



Sillones, butacas, lounge chairs, armchairs



# SOUL

Los sillones **Soul** de **Rafa García** son el resultado de una larga tradición y saber hacer; un producto discreto, cómodo y pequeño, tres cualidades fundamentales en un sillón. La sentada de **Soul** es extremadamente cómoda gracias a la reducida altura de su asiento y a un respaldo con riñonera, integrada en la estructura, que se adapta perfectamente a nuestro cuerpo. Podemos elegir entre distintos tipos de bases (patas o pie central) y zócalos (tapizado o de madera).

The **Soul** armchairs by **Rafa García** are the result of expert knowhow; a discreet, comfortable and compact product - three essential qualities in an armchair. It is extremely comfortable - thanks to the low seat height and a back with integrated lumbar cushion. We can choose between different types of legs (central revolving pedestal or fixed feet) and base (upholstered or wooden).



HERA by Enrique Martí, 2008



# HERA

**Hera** es una butaca completamente tapizada que está disponible en una extensa gama de tejidos, pieles y vinilos. Gracias a unas dimensiones muy estudiadas y proporcionadas, **Hera** de **Enrique Martí** nos permite dar soluciones a ambientes y proyectos de la más diversa índole.

**Hera** is available in a wide range of fabrics, leathers and vinyl. Thanks to its studied and proportioned dimensions, **Hera** by **Enrique Martí** allows us to provide solutions in different kinds of environments and for various projects.



NOMADA by Doblegé, 2002



# NOMADA

**Nómada** surge como fruto de la colaboración entre **Rafa** y **Miguel Ángel García**. Se trata una butaca viajera que ha dado varias veces la vuelta al mundo a través de los numerosos proyectos en los que ha participado. Compacta y de reducidas dimensiones, su clásico aire contemporáneo la convierte en un concepto básico para cualquier ambiente. Gracias a sus sólidos brazos de madera haya, resiste el paso del tiempo y los viajes.

**Rafa** and **Miguel Ángel García** collaborated to create **Nómada**. It is a small armchair that has travelled around the world several times through the numerous projects in which it has participated. Compact and with reduced dimensions, its classic contemporary style makes it a basic concept suitable for any environment. Its wooden arms, made of solid beech, helps **Nómada** to resist the passing of time.



Sillones, butacas, lounge chairs, armchairs

MOSS by La Cubitera, 2006



# MOSS

Dulzura formal para un diseño orgánico realizado por **La Cubitera**. La curvatura de las esquinas frontales resalta la forma en U del asiento y redondea la pieza. El pie central en forma de aspa caracteriza al modelo. **Moss** está disponible en versión fija y giratoria.

A formal study of the interaction between curves and straight lines by **La Cubitera**. The studio's attention to detail is highlighted by the curved outer edges of the seating area which have been mirrored by the seat cushion. The characteristic bent metal foot continues this theme and is also available in a swivel version.



CLUB by José Miguel Andrés, 2007



# CLUB

Solitario sillón. Infinito modular. De amplia versatilidad, este particular sillón permite realizar composiciones modulares a las que es posible incorporar brazos de madera o de acero. Para las composiciones no hay límite de piezas. La ergonomía de **Club** obedece a la suavidad de sus formas y materiales, **Club** es un diseño de **José Miguel Andrés**.

Endlessly modular. Highly versatile. This design allows us to make modular combinations with steel or wooden arms. There is no limit to the compositions: modules can be added ad infinitum. The ergonomics of **Club** is due to the smoothness of its shapes and the materials used. Designed by **José Miguel Andrés**.







# SILENCIO

Ricard Ferrer nos propone una pieza diferente e inclasificable. **Silencio**, no es una butaca pero tampoco es un diván; es una mezcla de ambas cosas. Esta indefinición contribuye a la versatilidad de una pieza que encaja a la perfección en dormitorios, salones y vestíbulos. Acompañada del puf ofrece una oportunidad ideal para el relax mientras leemos, escuchamos música o dormitamos.

The **Silencio** is an unusual one-of-a-kind piece designed by Ricard Ferrer. It is neither an armchair nor a divan. This lack of definition contributes to the versatility of a piece that is perfectly suitable for bedrooms, lounges and halls. With the pouf, it is perfect for relaxation while reading, listening to music or sleeping.



SILENCIO by Ricard Ferrer, 2002

Sillones, butacas, lounge chairs, armchairs

# Sillas Dining chairs





# MULLIT

**Un cojín con patas.** ¿A quién no le gusta acurrucarse en un mullido y confortable cojín? ¿Por qué no trasladar esta agradable sensación a una silla?

Partiendo de la alocada idea de "cojín con patas", Yonoh se puso manos a la obra. El resultado es Mullit, una silla en la que la originalidad de su diseño y la sencillez de sus formas es más que evidente.

El equilibrio de sus proporciones viene marcado por los contundentes volúmenes de almohadas de asiento y respaldo, así como por la ligereza visual que aportan sus patas, invitando a tomar asiento y disfrutar de una placentera experiencia.

Para reforzar el efecto mullido, hemos recurrido a un sutil fruncido textil e incorporado un vivo en el borde de las almohadas, imitando aún más si cabe la forma de un cojín.

La versatilidad de esta pieza se halla en la amplia oferta textil y en la singularidad de cada una de las bases disponibles: unas patas de madera despuntadas cual palillos, unas patas de varilla de metal con reminiscencias de otro tiempo bañadas en oro, otras de tubo de metal negro reducidas a la mínima expresión y una base central con ruedas.

**A cushion with legs.** Do you love snuggling a soft and soothing cushion? How about feeling the same in a chair?

This crazy idea of a "cushion with legs" was the starting point for Yonoh to roll up their sleeves and get down to work. The result is Mullit, an original chair with a formal design.

Its proportions are well balanced thanks to the overwhelming volumes of seat and back cushions set against the visual lightness provided by its legs, inviting you to take a seat and enjoy a pleasant experience.

To reinforce the fluffy effect, a subtle ruffle has been used on its back, as well as a piping; another nod to scatter cushions.

The wide range of textiles and a choice of bases contribute to the versatility of the chair: wooden legs that look like toothpicks, minimalist metal legs or electrolytic plating from a past epoch and a wheeled base.





Silla, dining chair



# MAGNUM

Inspirada en la exquisitez de Savile Row. Estudi{H}ac hace proyectos de alta costura con alto riesgo y su fundador, **José Manuel Ferrero**, es un auténtico gentleman.

Para **Ferrero** la elegancia es ante todo una actitud y los británicos saben mucho de esto; por ello la inspiración de **Magnum** nace de las copas de coñac que la alta sociedad londinense tomaba mientras discutía de política en sus exclusivos clubs.

Se trata de una familia de asientos especialmente diseñada para el sector de la hostelería, sin embargo, gracias a sus formas sinuosas, su elevado confort y reducidas dimensiones, tanto las sillas como los taburetes y butacas, pueden amueblar los hogares más singulares.

Esta polivalencia se materializa en una amplia oferta de tejidos y acabados para las bases, patas metálicas o de madera, con base tapizada, pie central o una base con ruedas.

Designed in the Savile Row tradition. Estudi{H}ac's **José Manuel Ferrero** might be Spanish, but his approach to design is akin to the bespoke tailoring of Mayfair.

His new range of soft seating for **Sancal, Magnum** pays homage to this very British elegance. The gentleman designer has drawn inspiration from the glasses of cognac members of exclusive London clubs cradle in their hands as they debate politics.

Comprising stools, lounge chairs and dining chairs, the range has been designed to withstand both demanding public spaces and domestic use. Even the smallest spaces can now enjoy luxurious comfort with these compact, fully upholstered pieces.

The products can all be customised by selecting from a wide array of options. The bases can be lacquered metal central feet, upholstery bases, four legs or a chair base with wheels.



MAGNUM by Estudi{H}ac, 2017



Silla, dining chair



Silla, dining chair





Butaca, armchair



Silla, chair

# NIDO

Rafa García ha ampliado la progenie de **Nido** con una silla tan ligera y sencilla como su predecesora. Al igual que la butaca, el nido que sirve de refugio y protección para un gran número de especies ha sido el elemento inspirador. Su suave y confortable sentada está sustentada por una base de madera de fresno que es el resultado de un artesanal trabajo de carpintería.

Sus reducidas medidas hacen de esta pieza una alternativa excelente para acompañar mesas de comedor o, por qué no, en oficinas, como silla confidente. Esta versatilidad también reside en las 4 alternativas para las patas: dos opciones en madera de fresno, disponibles en todos los colores de nuestra carta de tintes, una variante de varilla de metal con acabado epoxi negro y la opción con ruedas, que es giratoria y regulable en altura.

Rafa García has added a dining chair to the **Nido** product family with a design that is as simple as its predecessor. Just like the original lounge chair, a nest, serving as a refuge and protection for a large number of species has been the inspiration.

The seat or "nest" is supported by a hand-crafted ash wood frame or metal feet in a black-matte finish. Its small size turns this piece into an excellent alternative for dining tables or a side chair for any workspace. The chair's versatility can be found in the feet options: two ash wood types (available in 19 different colours), a metal version in a black epoxy finish or a swivel and height-adjustable variant.



NIDO by Rafa García, 2018



Silla, dining chair



# COLLAR

**Un asiento de atelier.** El estudio **Skrivo** parte del cuello de una camisa para crear una silla con el confort de una butaca. La silla **Collar** aúna tecnología y artesanía. El interior de espuma de poliuretano inyectada surge tras un complejo trabajo de modelado. El tapizado exterior está confeccionado como un traje a medida. Los botones tapizados a juego de la almohada de asiento son un reflejo de la importancia concedida a los pequeños detalles.

**Sancal** presenta una segunda versión de esta aclamada silla. El "apellido" **Mao** hace referencia a la simplificación de su estructura, ya que recuerda a los populares cuellos de camisa mao. Sin el "cuello" curvado a cada lado de los brazos, esta versión es más ligera y resulta perfecta para el comedor. Existen tres opciones para las patas: madera, metal y ruedas. El fresno está disponible en cualquier color de nuestra carta de tintes. El metal tiene un acabado epoxi texturizado negro.

**A chair from an atelier.** Designed by **Skrivo**, the inspiration for the initial concept was stimulated by the way a **collar** folds. **Collar** combines technology and handcraft. The injection-moulded interior followed intense modelling. The upholstery is tailored just like a made-to-measure suit. Even the buttons are upholstered to match the seat cushion, underscoring the importance of every last detail.

A second version of the product has been conceived by Sancal: the **Collar Mao**. The original design sports a wing collar, the new version reminds us of a mandarin collar: hence the **Mao** reference. This version is slightly lighter and thinner, making it ideal as a dining chair. The feet are available in wood, metal or wheels. The ash is available in any wood colour from our collection. The metal is available in black-matte textured epoxy.



Silla, dining chair



Silla, dining chair



## SILLA 40

**Homenaje al s. XX.** Coincidiendo con nuestro 40 aniversario, **Isaac Piñeiro** nos propuso realizar una silla por cada una de las 4 décadas que **Sancal** iba a cumplir. En lugar de 4 sillas completamente diferentes, el estudio decidió que el proyecto tendría mucha más unidad si tomábamos como punto de partida una única estructura que fuera común para las 4 décadas. De este modo, la diferencia entre una **Silla40** y otra radica en los respaldos, cada uno de los cuales se inspira en un momento histórico clave de la historia del mueble.

El respaldo **R20** simboliza las vanguardias y se inspira en la silla Cesca de Marcel Breuer. El respaldo **R30** es un homenaje al diseño escandinavo de los años 30 y se inspira en la silla 69 de Alvar Aalto. El respaldo **R40** representa el diseño orgánico de los años 40 al 60 y se inspira en las LCW de Charles y Ray Eames. Las corrientes creativas postmodernas de los 70 están representadas por el respaldo **R70**, el cual se inspira en la silla Synthesis 45 que Ettore Sottsass diseñó para Olivetti. La **Silla40** combina madera de fresno con asientos y respaldos tapizados. El fresno está disponible en cualquier color de nuestra carta de tintes. Para el tapizado ofrecemos nuestro amplio muestrario.

**A tribute to the 20th Century.** To commemorate **Sancal's** 40th anniversary, **Isaac Piñeiro** proposed the concept of designing four chairs, one for each of **Sancal's** decades. Instead of four totally different chairs, he decided that the project would make even more sense if each chair shared the same structure. This way the difference lies in the backs; each one inspired by a key moment in the history of furniture design.

The **R20** back symbolises concepts drawn from the work of Marcel Breuer and his Cesca chair. The **R30** back is a nod to Scandinavian design in the '30s and, in particular, the 69 chair by Alvar Aalto. The **R40** variant represents the organic design of the '40s, '50s and '60s and celebrates the LCW chairs designed by Charles Eames. The postmodern influences of the '70s are impregnated in the **R70**, inspired by designs like those of Synthesis45 by Ettore Sottsass for Olivetti. The **Silla40** combines an upholstered seat and back with ash feet and arms. The wood is available in any colour from our range of ash stains, and any fabric can be chosen from our entire collection.



SILLA 40 by Isaac Piñeiro, 2014

Silla, dining chair



SILLA40 by Isaac Piñeiro, 2014

Silla, dining chair



# ARTICA

Pese a los sucesivos intentos por parte de la competencia por igualar el porte de las **Ártica**, ellas siempre conservan la rotunda presencia de un diseño sobresaliente y exclusivo realizado por **Rafa García**. Pero en realidad, lo que las hace inconfundibles es la calidad de una sentada muy estudiada. La colección se compone de butaca y silla.

Despite ongoing attempts by our competitors to replicate the air of **Ártica**, they are unable to imitate the expressive presence of an exclusive and outstanding design by **Rafa García**. Really, what makes **Ártica** unmistakable is the quality of the considered, unique seat frame. The collection is made up of armchair and narrow-armed chair.



ARTICA by Rafa García, 2002



Silla, dining chair

# TEA

José Manuel Ferrero, ha reducido la butaca **Tea** a su mínima expresión. El resultado: una ligera y confortable silla con esbeltas patas de madera. La forma curvada del respaldo favorece una postura ergonómica y proporciona una sentada de larga duración. Su delgada estructura es sólida y esponjosa gracias al poliuretano inyectado. Al igual que el resto de piezas de la colección **Tea**, las sillas incorporan el acolchado hexagonal y la posibilidad de crear piezas bicolor. Las patas también están disponibles en roble o haya, así como con base de ruedas.

José Manuel Ferrero has reduced the lounge chair to its minimum expression. The result: a light and soft chair with slender wood legs. The curved shape of the back is supportive yet flexible, thanks to the injected polyurethane. As well as the rest of the **Tea** Collection, the chairs incorporate hexagonal quilting and the possibility of creating both bi-coloured pieces. Oak and beech feet are available, and also a wheeled base.



Silla, dining chair



# MIDORI

**Midori** es la joven inquieta de Tokio Blues. La melodía de esta novela es Norwegian Wood, un tema de los Beatles que inspiró a **Ebuàl** para dar nombre a esta escandinava familia de asientos de madera de fresno. El cojín de decoración opcional aumenta el confort de la butaca y le da un toque hogareño. Los taburetes incorporan un reposapiés de acero inoxidable.

**Midori** is the anxious young woman from the Japanese novel that inspired **Ebuàl**. The optional extra lumbar cushion increases the comfort of the lounge chair and gives it a cosy feeling. The bar stools have satin stainless steel footrests.



Silla, dining chair

# Bancos Benches







# INTERCHANGE

**Cruce de caminos.** **Interchange** se inspira en la celosía de la cubierta de la estación Turati, un elemento tan arquitectónico como gráfico.

El sobre, elaborado con madera de fresno maciza, dispone de dos medidas y sirve de soporte para realizar extensas configuraciones al combinar variadas geometrías, materiales y usos. Gracias un sencillo sistema de fijación, es posible acoplarle diferentes elementos. De este modo, el banco puede incorporar asientos que potencian su confort o mesas de diversas formas y acabados.

Las mesas pueden ir ajustadas al perímetro delimitado por el perfil del sobre o volando parcialmente sobre este. Por el contrario, los asientos tapizados deben colocarse dentro de su perímetro.

La lista de opciones queda completada con los acabados disponibles: 8 colores de tinte para el sobre enrejado, 19 colores de tinte para las mesas de fresno, 4 colores de lacado alto brillo para las mesas de DM, e infinidad de tejidos, vinilos y pieles para los asientos tapizados.

Las discretas patas son de acero en acabado epoxi negro texturado y pasan casi inadvertidas en la totalidad de las composiciones.

**Crossroads.** **Interchange's** bench base is inspired by the architectural forms of Turati station's lattice ceiling. A highly adaptable solution, it combines geometry, materials and functions.

The solid ash wood lattice is available in two sizes and serves as a support for a range of configurations. Different elements can be fixed through the holes with a simple fastening system. This way, the bench can incorporate comfortable seats or tables with different shapes and finishes.

The tables can be fitted to the outer edge of the bench or even poke out slightly. The seats, on the other hand, must always be placed entirely with the perimeter of the lattice.

The personalisation options are completed with eight stain colours for the bench, nineteen stain colours for the ash tables, four high gloss lacquer colours for MDF tables, and endless fabric, vinyl and leather options for the seat cushions.

The discreet legs are made of steel in a textured black epoxy finish.





# LA ISLA

**Un acogedor refugio para navegantes.** Este proyecto de **Note Design Studio** para **Sancal** es un asiento para colectividades que responde a la proliferación de lo que Marc Augué denominara “no-lugares”.

Cada vez con más frecuencia nos vemos expuestos a zonas de tránsito; no-lugares generalmente inhóspitos y poco afectivos. Sancal ha confiado en el saber hacer del estudio sueco, con la intención de mejorar la experiencia de quienes viajan, ya sea por trabajo o placer. **Note** ha creado un espacio de paso que permite usos simultáneos sin interferencias. Un lugar para compartir con desconocidos, pero respetuoso con nuestra privacidad; aislado, pero no excluyente.

**La Isla** es un banco con identidad, de amplias proporciones, generoso y amable. Perfecto para tomar un respiro en la recepción de un hotel o en la zona de espera de un aeropuerto. Su oronda silueta y curvas sinuosas crean una sentada tierna y sedosa. La familia consta de 3 medidas y una extensa gama de tejidos. El zócalo está disponible en todos los colores de nuestra carta de lacados.

**An enticing destination in a sea of nothingness.** As we travel more, we continually find ourselves in transit areas – vast seas of inhospitable and unwelcoming space that Marc Augué has dubbed “non-places”.

**Sancal** turned to **Note**, a Swedish design studio to provide some relief for weary travellers. They came up with **La Isla** as a solution. Its seductive curves and soft upholstery call out to all those navigating a lobby, desperately seeking refuge. A place to share with strangers while respecting their privacy; isolated but not excluded.

Once installed on **La Isla** they will not be disappointed. The upholstery is just as comfortable as it looks with generous proportions and soft materials. **La Isla** comes in three different sizes and a selection of fabrics from Sancal’s collection. The plinth can be lacquered in any of the colours as per the chart in the price list.







# MOSAICO

**Un puzzle para componer múltiples figuras.** Junto al estudio creativo **Yonoh**, **Sancal** presenta un singular programa de mesitas y asientos ocasionales. Dadas las raíces valencianas de **Clara** y **Alex** no es de extrañar que recurrieran a la cerámica como fuente de inspiración.

**Mosaico** es un puzzle con el que componer soluciones espaciales adaptables a cualquier necesidad. Las bases son de madera de fresno y están disponibles en 5 medidas a las cuales podremos añadir tapas de mármol o madera y almohadas de asiento tapizadas en infinidad de tejidos. Los respaldos opcionales brindan además la posibilidad de transformar los pufs en pequeños sofás. La pieza hexagonal permite, entre otras posibilidades, crear composiciones de 360°. La mesa ángulo aporta sinuosidad al diseño gracias a su lado curvo.

**A puzzle with more than one solution.** Together with the design studio **Yonoh**, **Sancal** presents a unique program of occasional tables and seating solutions. **Clara** and **Alex** are both from Valencia, a Spanish city renowned for its ceramic tiles, so it seems only fitting that this provided the inspiration for the piece.

**Mosaico** is a puzzle that can be used to solve a range of different spatial constraints. The bases are made of ash and are available in five measurements upon which marble or wooden tops can be fitted as well as upholstered seat cushions. The optional backs enable the pieces to be transformed into mini-sofas. The hexagonal piece enables, amongst other possibilities, the creation of compositions that make closed loops. The corner angle adds an element of sinuosity to the design with its curved side.



MOSAICO by Yonoh, 2015







# REW

Es el acrónimo de **rest-eat-work** (descansar-comer-trabajar). El significado literal de esas palabras define a la perfección la funcionalidad del programa de asientos **REW**.

Al igual que los sofás **REW** también es un amplio abanico de bancos y bancadas para acompañar todo tipo de mesas de comedor. Los bancos pueden ir solos o en compañía de paneles de pared tapizados. Las bancadas están disponibles con dos fondos (57 y 72 centímetros). El fondo más corto encaja con el prototipo tradicional de bancada y proporciona una sentada más firme y recta. Además, la terminación en esquina de los brazos altos permite realizar composiciones con ángulos rectos. El fondo más largo tiene una medida ideal para llenarlo de cojines de decoración y generar una sentada más informal, perfecta para largas sobremesas. Asimismo, **Rafa** propone dos alturas de respaldo (L y XL). El respaldo bajo potencia la ligereza del diseño. Los respaldos altos proporcionan intimidad.

**An acronym for rest-eat-work.** This creation by **Rafa García** is tremendously versatile, and can be used for a variety of diverse projects that require pieces for resting, eating or working.

As well as a sofa, the **REW** is also a wide range of benches which can be used with a dining table. The benches can be used alone, or together with upholstered wall pieces. The benches are available in two depths (shallow and deep). The least deep is the archetypal dining bench, providing a firm, upright sitting position. Moreover, the finish of the arms in a corner permits compositions with angles to be made. The deeper version is ideal to fill with scatter cushions and create an informal environment, perfect for long postprandial conversations. **Rafa's** piece provides two back heights, L and XL. The low back creates a light design, while the higher backs provide some privacy.



REW by Rafa García, 2014





# KONOHA

Del algoritmo de la doble espiral, por naturaleza, surge una forma única. **Toyo Ito** se ha inspirado en esta particular forma para diseñar un mobiliario que facilite el encuentro entre la gente y permita usar los espacios libremente. El resultado son unos bancos de silueta vegetal, similares a los fragmentos de una planta, con los que podemos componer una hoja completa.

Combinando las diferentes piezas de la serie, obtenemos diferentes ritmos. Cambiando la posición u orientación de los bancos, podemos modificar el contexto y adaptarnos a las dimensiones de cualquier espacio. Para los acabados, apuesta por materiales nobles: lana, madera y acero con el fin de potenciar el componente orgánico del diseño. **Kono**ha es una palabra japonesa que significa "hojas de árbol".

From the algorithm of the double helix arises a unique form of Nature. **Toyo Ito** has been inspired by this particular shape to design furniture that facilitates connection among people and that allows free use of spaces. The result is a bench with a unique silhouette, similar to the fragments of a plant, with which we can compose a full leaf.

By combining the pieces of the series in different ways, we alter the rhythms. By changing the position or orientation of the benches, we can modify the context and adapt to the dimensions of any space. **Toyo Ito** uses natural materials: wool, wood and steel to enhance the organic component of the design. **Kono**ha is a Japanese word that means "tree leaves".



KONOHA by Toyo Ito, 2010



# NUDO

La colección **Nudo** es muy extensa. Las mesitas auxiliares, realizadas en roble natural, roble tintado o mármol, tienen distintas alturas y medidas de tapa. Su ligereza y amplia variedad de acabados y tamaños, permiten crear interesantes combinaciones y darles un uso alternativo.

Tras el éxito cosechado por esta familia de mesas, **Juan Ibáñez** nos propone una pieza multifuncional: una **mesita-banco** con cojines bicolor. Recurrimos a un acabado que simula el encerado tradicional para respetar la nobleza de la materia prima y conseguir un tacto suave sin alterar la calidez del roble natural.

The **Nudo** table collection is very comprehensive. The small tables, in natural or stained oak or marble, vary in height and top sizes. The lightness and wide variety of sizes and finishes enable the creation of interesting combinations, giving them alternative uses.

Following on from his success with this family of tables, **Juan Ibáñez** has added an ingenious multifunctional piece: a table/bench with two tone cushions.





# MENU

**Menú** satisface las necesidades de cada proyecto; así surgen sus múltiples opciones: zócalo de haya, zócalo tapizado, patas de metal, patas de madera y respaldos con o sin botones. **Rafa García** ha creado esta bancada con el propósito de ofrecer un diseño diferenciado, a la vez que discreto, porque las bancadas de bares y restaurantes tienen que encajar perfectamente en el espacio sin desentonar, sin romper la armonía del ambiente.

**Menú** también funciona como pieza de hogar en salones y cocinas. A parte de la modulación estándar, existe la posibilidad de hacer medidas especiales que se ajusten a las necesidades de cada proyecto, para ello es preciso consultar con el departamento comercial.

The **Menú** was conceived to satisfy the requirements for each project; thus, multiple options are available: beech base, upholstered base; metal feet, wooden feet; back with or without buttons. **Rafa García** has created these benches in order to offer a different and also discreet design, since the benches in bars and restaurants have to fit the space perfectly.

The **Menú** also serves as a domestic piece for lounges and kitchens. Apart from the standard measurements, it is also possible to make special sizes in order to meet the needs of each project: in these instances, **Sancal's** sales department must be consulted.



Bancos, benches

Pufs  
Taburetes  
Poufs  
Stools



# MEETING POINT

**Encuentros con desconocidos.** Meeting Point es un sistema de pufs con mesas. El círculo es el elemento formal dominante en toda la familia. A los redondeados asientos tapizados de 60 y 90 centímetros de diámetro, le acompañan redondas mesitas de madera o metal de diferentes medidas y acabados.

Las livianas patas son siempre de acero en acabado negro epoxi texturado y crean un efecto óptico de falsa levitación, pues parece que almohada y mesas estén suspendidos en el aire. Las mesas de metal están disponibles en oro y negro texturizado y las de fresno en todos los colores de nuestra carta de tintes. Los asientos se pueden tapizar en una oferta interminable de textiles, vinilos y pieles.

**Strangers on the station.** Meeting Point is a pouf system which also integrates tables. The circle is the dominant shape. Upholstered seats with a diameter of 60 or 90 centimetres are accompanied by round wooden or metal tables of different sizes and finishes.

The thin steel legs, coated in textured black epoxy, create an illusion of levitation, as if the seats and tables are suspended in mid-air. The metal table tops are available in textured black or a gold finish while the ash tables are available in all the colours of **Sancal's** chart. The seats can be upholstered in an endless array of fabrics, vinyl and leathers.

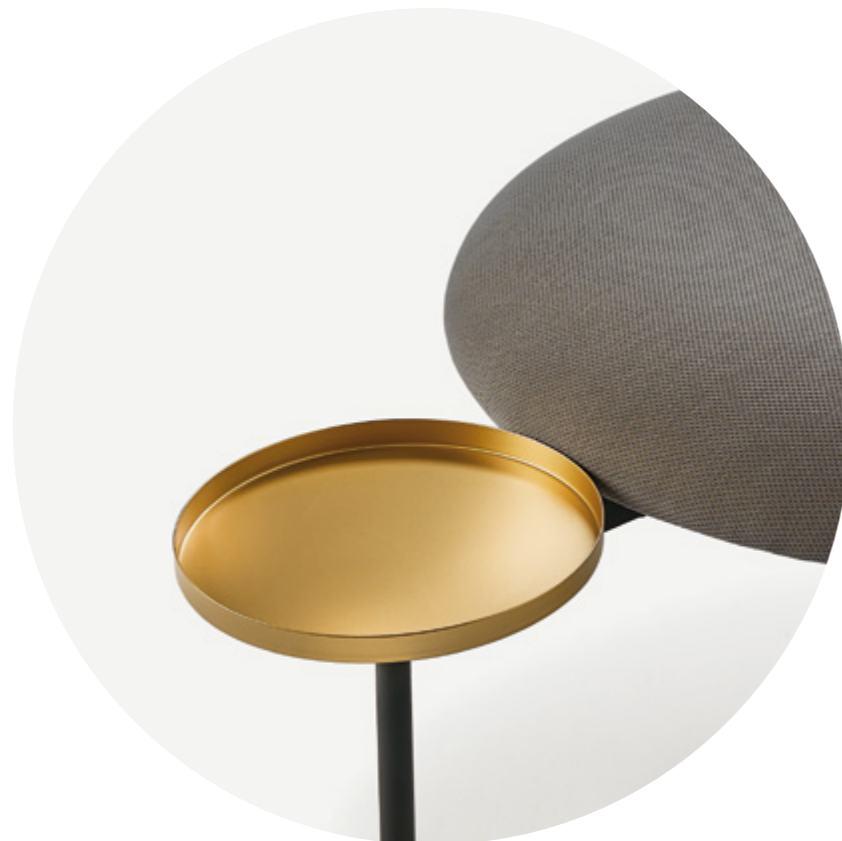

MEETING POINT by Nichetto Studio, 2019



Pufs, taburetes, banquetas, poufs, stools







# ELEPHANT

Tras la huella del paquidermo... Isaac Piñeiro vuelve a hacer gala de su acertada visión para las piezas pequeñas, creando una familia de pufs con formas muy básicas (cuadrados y rectángulos), con la peculiaridad de que todas sus esquinas han sido redondeadas.

La familia consta de 3 pufs: uno de 45x45, otro de 90x45 y un tercero de 90x45 con bandeja de madera. Divertidos y versátiles encajan en cualquier lugar: como asiento a los pies de la cama, como banqueta en una cafetería chic o como pequeñas islas en una recepción.

On the trail of a pachyderm... Isaac Piñeiro surprises us again with a fresh vision for small, yet essential pieces. The **Elephant** is a family of poufs with simple, geometric squares and rectangles which have had their edges rounded to give a slightly more welcoming feel.

This family comprises three poufs, one of 45x45 and another measuring 90x45 - which is also available with a wooden tray. Fun and versatile, they can fit into any setting: as a seat at the foot of a bed, a stool in a chic café or as small islands in a hotel reception.





# TAB

Isaac Piñeiro nos propone unas simpáticas banquetas y mesitas cuya base está inspirada en los trobos, unas colmenas hechas con troncos de madera, muy típicas en el norte de la Península Ibérica.

Tab son 2 banquetas con diferente altura y 4 mesas. La base siempre es de chapa de castaño curvada y las tapas están disponibles en chapa de castaño y en un amplio abanico de lacados.

Isaac Piñeiro projected an interesting small family of stools and small tables, the bases of which are inspired by 'trobos': a Spanish word that describes hives made from hollow logs.

The Tab is a stool with 2 different heights, and 4 tables. The base is always in curved chestnut veneer and the tops are available in a matching veneer or a wide range of lacquers.



# CHAT

**Chat** es un espacio de reunión, un lugar como punto de encuentro, un símbolo de la interacción entre personas. **Chat** es una colección de pufs y taburetes concebida como complemento de ambientes hogareños, que, en espacios colectivos, facilita la creación de lugares comunes. Se trata del tipo de mobiliario más apropiado para crear pequeñas privacidades en entornos públicos.

De formas amables y sencilla geometría, **Chat** se fusiona con el resto de elementos arquitectónicos que definen cada espacio. La combinación bicolor de los tejidos facilita su adaptabilidad a diferentes entornos. Con este proyecto, **Isaac Piñeiro** multiplica las posibilidades de crear diferentes espacios sensoriales, alegres, coloristas y serenos. **Chat** ofrece emoción al mueble tapizado.

The Chat makes any space a meeting point. They are a collection of poufs and stools conceived as a complement for home-like environments or in public spaces. Its pleasant and easy geometry merges with the rest of the architectural elements defining each space.

The bicolour fabric combination facilitates different ambiances. With this project, **Isaac Piñeiro** creates sensory, cheerful, colourful and serene spaces. The **Chat** brings emotion to upholstered furniture.



CHAT by [Isaac Piñeiro](#), 2013



# TONELLA

**Del tocador al mundo entero.** Tras el éxito de esta pequeña butaquita de tocador, Note nos propuso aumentar la familia, pero en lugar de hijos, **Tonella** asistió al nacimiento de sus padres. Continuando con el tonel como inspiración **Note** proyectó un sillón y un sofá de mayor tamaño y con una sentada más relajada. El tapizado de las almohadas interiores es liso mientras que la parte exterior del respaldo es acolchado con un dibujo de líneas verticales para simular que las duelas del tonel trepan por la estructura.

Recientemente se ha sumado a esta distinguida saga un esbelto taburete y dos pufs, para completar con dinamismo y versatilidad las piezas que conforman esta familia. En ambos casos, las duelas del tonel siguen siendo el elemento común: mientras que en el taburete las varillas metálicas adquieren mucho más protagonismo dotando a la pieza de una estética liviana, en los pufs su presencia es mucho más sutil ya que el asiento adquiere todo el protagonismo por su oronda forma.

**A trip around the world that started at a vanity table.** After receiving an excellent reception, **Note** added a new member to the family: thus our petite **Tonella** has presented the birth of its parents. Spanish wine barrels remain the inspiration for the larger sofa and armchair. The straight line quilting runs down the outside of the piece, like staves, contrasting with the smooth interior cushions. The Marie Antoinette-style seat, back and arms are made from flexible moulded polyurethane foam. The plain interior area can be upholstered in fabric or leather, the outer area is quilted to follow the barrel style lines of the base and is therefore only available in fabric.

Recently, a slender stool and two pufs have been added to this distinguished saga. As with the other products in the range the "staves" feature prominently: the metal rods on the stool acquire greater prominence and give the piece an ethereal aesthetic, while the puffs' chubby upholstered seat is held aloft by a metallic cage and subtle support.



TONELLA by Note, 2017





# MAGNUM

Inspirada en la exquisitez de Savile Row. Estudi{H}ac hace proyectos de alta costura con alto riesgo y su fundador, **José Manuel Ferrero**, es auténtico gentleman.

Para **Ferrero** la elegancia es ante todo una actitud y los británicos saben mucho de esto; por ello la inspiración de **Magnum** nace de las copas de coñac que la alta sociedad londinense tomaba mientras discutía de política en sus exclusivos clubs.

Se trata de una familia de asientos especialmente diseñada para el sector de la hostelería, sin embargo, gracias a sus formas sinuosas, su elevado confort y reducidas dimensiones, tanto las sillas como los taburetes y butacas, pueden amueblar los hogares más singulares.

El taburete está disponible en dos alturas, con patas metálicas en color oro o expoxi negro.

**Designed in the Savile Row tradition.** Estudi{H}ac's **José Manuel Ferrero** might be Spanish, but his approach to design is akin to the bespoke tailoring of Mayfair.

His new range of soft seating for **Sancal**, the **Magnum**, pays homage to this very British elegance. The gentleman designer has drawn inspiration from the glasses of cognac members of exclusive London clubs cradle in their hands as they debate politics.

Comprising stools, lounge chairs and dining chairs, the range has been designed to withstand both demanding public spaces and domestic use. Even the smallest spaces can now enjoy luxurious comfort with these compact, fully upholstered pieces.

The stool is available in two sizes and there are two metal structure options: gold or black.





# TEA

José Manuel Ferrero presenta el taburete de bar. La forma curvada del respaldo favorece una postura ergonómica y proporciona una sentada de larga duración. Su delgada estructura es sólida y esponjosa gracias al poliuretano inyectado.

La colección **Tea** se caracterizan por incorporar un original acolchado de trama hexagonal en las zonas de asiento y respaldo. Un fino vivo delimita dicho acolchado y lo diferencia del tapizado liso de la base. Al igual que sus predecesoras el taburete incorpora el acolchado hexagonal y la posibilidad de crear piezas bicolor.

José Manuel Ferrero presents the bar stool. The curved shape of the back supports an ergonomic posture and provides a comfortable seating position. The slim frame manages to be both solid and spongy, due to the use of moulded polyurethane foam.

Like their predecessors, the bar stool incorporates hexagonal quilting and the possibility of creating two tone pieces by selecting different materials for the outside and inner seating areas.





# MIDORI

**Midori** es la joven inquieta de Tokio Blues. La melodía de esta novela es Norwegian Wood, un tema de los Beatles que inspiró a **Ebualà** para dar nombre a esta escandinava familia de asientos de madera de fresno. El cojín de decoración opcional aumenta el confort de la butaca y le da un toque hogareño. Los taburetes incorporan un reposapiés de acero inoxidable.

**Midori** is the anxious young woman from the Japanese novel that inspired **Ebualà**. The optional extra lumbar cushion increases the comfort of the lounge chair and gives it a cosy feeling. The bar stools have satin stainless steel footrests.



Pufs, taburetes, banquetas, poufs, stools

# PERIGALLO

**Apego al terreno.** Perigallo se denomina así a un artilugio típico de la huerta levantina, similar a una escalera de tres patas, que se usa para recolectar la cosecha.

El equipo de trabajo constituido por **Domínguez, García e Ibáñez** rescata esta tradición y la reinventa dotándola de nuevos usos. El **Perigallo** contemporáneo es un taburete plegable que también sirve como galán de noche. Estructura es de fresno tintado en seis colores y seis tejidos combinables para tapizar la montera o asiento.

**Love of the land.** Perigallo is used to describe a three legged ladder used to harvest local fruit. **Domínguez, García & Ibáñez** borrowed this traditional idea and have given it a new use.

**Sancal's Perigallo** is a stool that can be folded away when not in use, making it ideal for hosts who suddenly find that they need more seating. The structure is ash and can be stained in a choice of six colours from our collection. The seat can be upholstered in six fabrics.





# Acústicos Acoustic products



# ESTANTE

¡Tela, metal y madera!. Estante es un versátil y alegre mueble modular con propiedades fonoabsorbentes, diseñado por Juan Ibáñez Lax.

Los estantes de aluminio son el esqueleto, la pieza central entorno a la cual gira todo. A ellos se añaden las patas y pilastras de roble que los sustentan. Pero sin duda, la máxima distinción viene dada por las piezas textiles que los engalanan.

Los módulos y puertas tapizadas revisten los estantes e incorporan un diseño fonoabsorbente, trascendiendo así la función decorativa. Las puertas favorecen el contraste de materiales. Las puertas de aluminio han sido perforadas para generar una atractiva textura y no obstaculizar la fono-absorción.

Estante amplía el concepto de almacenaje auxiliar. Dependiendo de cómo sea configurado hace las veces de aparador, recibidor, librería, mueble de tv y hasta de separador de ambientes. La posibilidad de incorporar ruedas incrementa su funcionalidad.

Las patas de roble pueden ser tintadas en toda la carta de colores, lo cual amplía las opciones de personalización.

Oak, fabric and aluminium play quietly together! Estante by Juan Ibáñez Lax is a modular piece of furniture with acoustic properties.

The aluminium shelves provide the platform upon which everything else is built. Oak pillars and feet screw into place to create the structure which is then adorned by perforated aluminium or upholstered doors and panels.

These textile elements dress the Estante and add a sound-absorbing function, going beyond mere decoration. The perforated aluminium doors present an attractive contrast while minimising acoustic interference.

The furniture's highly configurable design transcends its storage function as it can be used as sideboard, bookcase, television stand or a divider. Add wheels to create a trolley or invent your own use case!

The oak legs are available in a wide range of colours, providing yet more personalisation.



ESTANTE by Juan Ibáñez Lax, 2019





# BEETLE

Un paisaje sonoro esculpido por insectos... Tras un paseo por el museo de ciencias naturales, **MUT Design** se inspira en las salas de entomología y sus espeluznantes expositores de insectos, para crear los bichos más bellos e inofensivos jamás vistos.

El proyecto del consolidado estudio valenciano para **Sancal** partió de la necesidad de resolver el incómodo problema del ruido ambiente y hacerlo sin que lo parezca; superando el difícil equilibrio entre funcionalidad y decoración. Los paneles fonoabsorbentes **Beetle** son esculturas textiles que sobredimensionan el arquetipo de un escarabajo.

Con un total de 6 paneles obtenemos 13 composiciones o escarabajos diferentes. En cuanto a los acabados, es posible realizar tantas combinaciones de color como te permitan los textiles. El soporte es de madera de roble y se puede tinter en cualquiera de los colores de nuestra carta.

**Soundscapes sculpted by insects...** After meandering through the Natural Science Museum, **MUT Design Studio** became inspired by the exhibition rooms dedicated to entomology and their terrifying showcases of insects. Their own bug, however, would be beautiful and harmless.

Their project for **Sancal** started with the need to resolve the uncomfortable problem of background noise, overcoming the difficult balance between sound dissipation and decoration. The sound-absorbing panels are textile sculptures that oversize the perfect specimen of a beetle.

By carefully combining the product's 6 panels, Sancal has created 13 different Beetle variants. As for the finishes, a variety of textile combinations are available. The stand is made of oak wood and can be tinted in any of the colours in our chart.

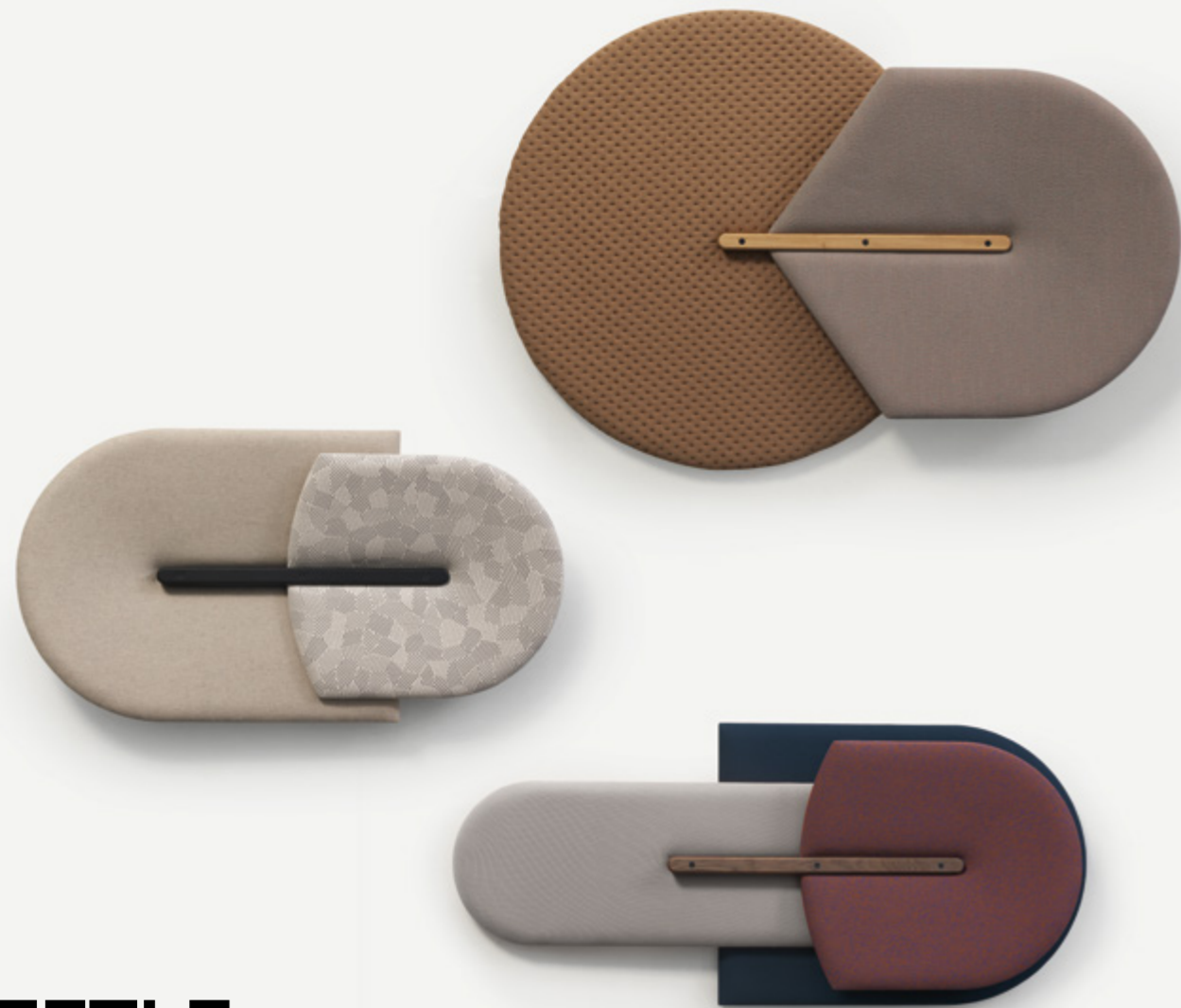

BEETLE by MUT Design, 2017



Acústicos, acoustic products

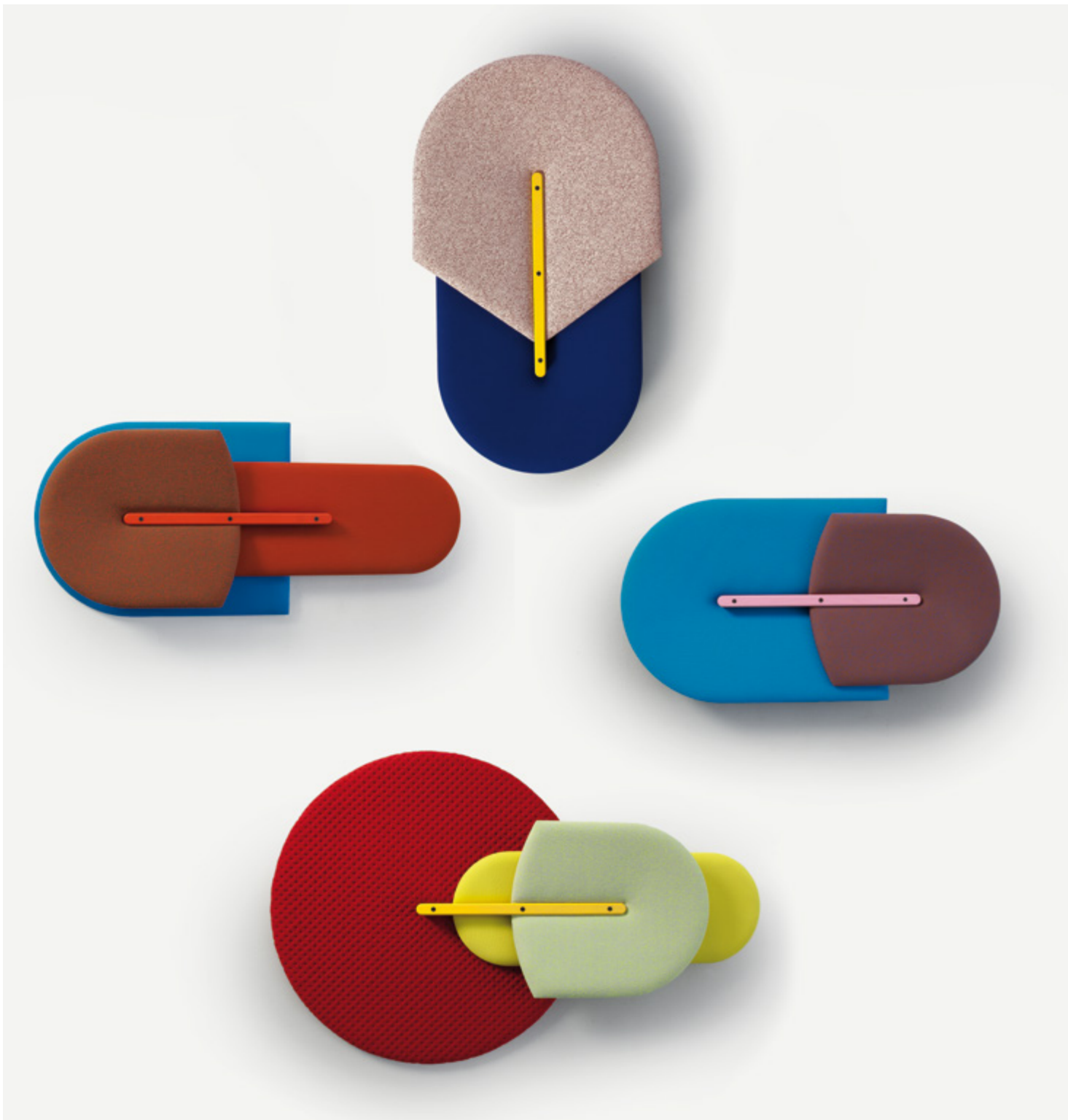

# TARTANA

**Isaac Piñeiro** se remonta a una época preindustrial para crear un producto postindustrial. Según el diccionario de la RAE, una tartana es un “carruaje con cubierta abovedada y asientos laterales, por lo común de dos ruedas y con limonera”.

La **Tartana** contemporánea es una cúpula acústica, un producto totalmente novedoso pensado para resguardarnos y darnos la intimidad que añoramos cuando cohabitamos amplios espacios públicos.

Los materiales empleados son cálidos con el objetivo de incrementar la sensación de recogimiento. La estructura es de fresno y los textiles son de fieltro foamizado. La parte textil está disponible en las siguientes combinaciones de tejidos: sand, bloom, cobalto, fog, fire y lemon. Ambas caras son polivalentes por lo que es posible colocarlas hacia arriba o hacia abajo indistintamente. Consulte con el departamento comercial la viabilidad de otros colores para el textil. La confección del textil en tres capas proporciona una fono-absorción óptima.

Como novedad cabe destacar la versión con led integrado, que convierte la cúpula en una lámpara

**Isaac Piñeiro** has taken inspiration from a pre-industrial epoch for their post-industrial product. In Spanish, a “tartana” is defined as a carriage with a

domed cover on two wheels. **Sancal's** modern-day **Tartana** is an acoustic dome, a totally new product, designed to protect us and provide us with the privacy that we yearn for in open spaces.

The warm materials used help to create a cosy atmosphere: the structure is ash and the fabric is a foam laminated. The textile part is available in the following fabric combinations: sand, bloom, cobalto, fog, fire and lemon. Both sides have the same acoustic properties and can therefore be placed either way round to achieve different colour co-ordinations. Please check the viability of other finishes with the sales department before ordering.

The construction of the fabric in three layers creates the optimum phono-absorbent effect.

A new version features LEDs, converting the **Tartana** into a lamp.



TARTANA by Isaac Piñeiro, 2014





# Mesas Tables





# INTERCHANGE

**Cruce de caminos.** La pieza principal de este polivalente modelo es el banco que se inspira en la celosía de la cubierta de la estación **Turati**.

El sobre, elaborado con madera de fresno maciza, dispone de dos medidas y sirve de soporte para realizar extensas configuraciones. Gracias a los huecos de su estructura y a un sencillo sistema de fijación, es posible acoplar diferentes elementos. De este modo, el banco puede incorporar asientos que potencian su confort, mesas de diversas formas y acabados, o paneles que dividen el espacio y crean intimidad.

Las mesas pueden ir ajustadas al perímetro delimitado por el perfil del sobre o volando parcialmente sobre este. Por el contrario, los asientos tapizados deben colocarse dentro de su perímetro.

La lista de opciones queda completada con los acabados disponibles: 8 colores de tinte para el sobre enrejado, 19 colores de tinte para las mesas de fresno, 4 colores de lacado alto brillo para las mesas de DM, e infinidad de tejidos, vinilos y pieles para los asientos tapizados.

Las discretas patas son de acero en acabado epoxi negro texturado.

**Crossroads.** The bench base is inspired by the architectural forms of **Turati** station's lattice ceiling. A highly adaptable solution, it combines geometry, materials and functions.

The solid ash wood lattice is available in two sizes and serves as a support for a range of configurations. Different elements can be fixed through the holes with a simple fastening system. This way, the bench can incorporate comfortable seats, tables with different shapes and finishes, or dividing panels.

The tables can be fitted to the outer edge of the bench or even poke out slightly. The seats, on the other hand, must always be placed entirely within the perimeter of the lattice.

The personalisation options are completed with eight stain colours for the bench, nineteen stain colours for the ash tables, four high gloss lacquer colours for MDF tables, and endless fabric, vinyl and leather options for the seat cushions.

The discreet legs are made of steel in a textured black epoxy finish.

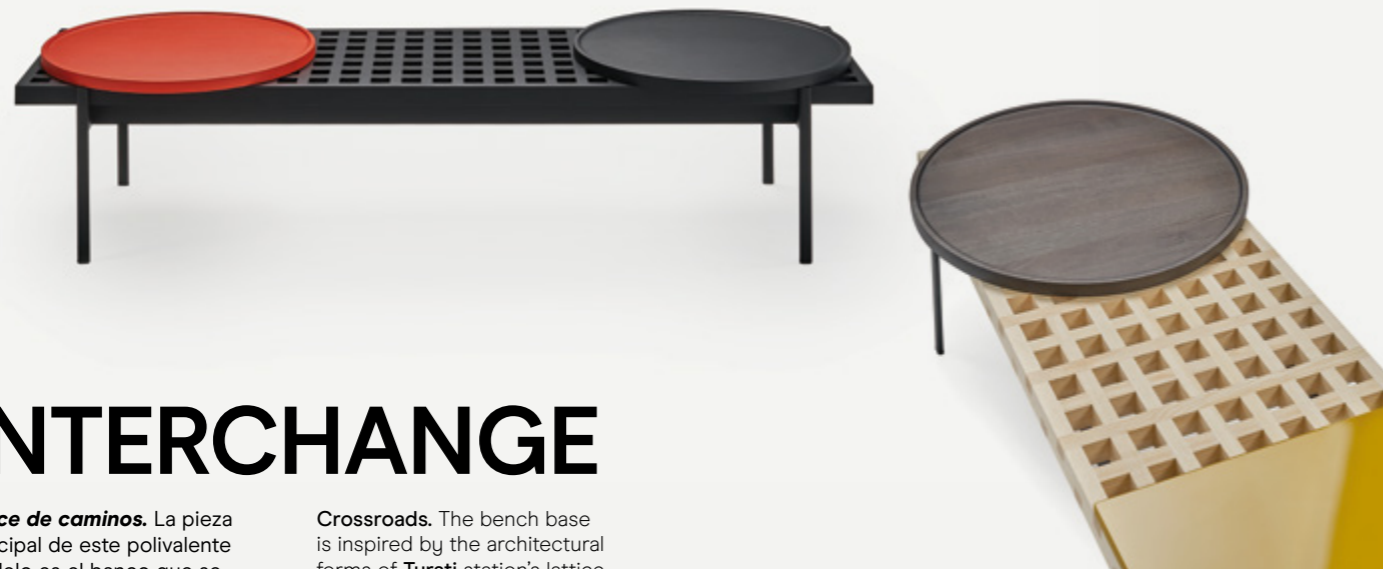

INTERCHANGE by *Nichetto Studio*, 2019



# LA ISLA

**Un acogedor refugio para navegantes...** Las nuevas mesitas auxiliares amplían la oferta de la colección de bancos para colectividades concebida por el estudio sueco **Note**. Al igual que en los asientos, lo más característico de ellas son las líneas curvas. Sus 3 alturas y la forma de sus sobres, redondo u ovalado hacen que puedan interactuar entre ellas.

Las bases, con forma de aspa, recuerdan formalmente al respaldo de los bancos, sin duda el elemento distintivo común a toda la familia. Los sobres son de cristal fumé por lo que dejan entrever la tan característica base, la cual puede ser lacada en todas las opciones de laca de nuestra carta.

**An enticing destination in a sea of nothingness...** The occasional tables complete the acclaimed La Isla archipelago by the Swedish Studio **Note**, and continue with the same design language based on curves. Three heights are available and the tabletops are available in round or oval versions, allowing them to interact with each other.

The fumé glass tops enable us to view the bases, shaped like blades as a nod to the benches' backs, they can be lacquered as per our colour chart.





# DUMBBELL

Un ejercicio de fuerza. Dumbbell es un término de origen anglosajón que hace referencia a las pesas empleadas para desarrollar la musculatura de brazos y hombros.

Su acabado monocolor en blanco, negro, gris o teja refuerza el carácter macizo de las mesas, aligerado sólo por el perfil en tono natural de la tapa.

Para su construcción se han seleccionado materiales sólidos y resistentes como el tablero marino y el laminado de alta presión tanto en las tapas y como en las bases, mientras que el pie central es de acero lacado.

La extensa variedad de opciones disponibles se debe a la combinación de las diferentes medidas y formas de sus sobres redondos o cuadrados, así como por las cinco alturas proyectadas y los 4 colores seleccionados para todas ellas.

**An exercise in design!** Dumbbell by Estudio Sancal is a wide collection of tables inspired by the symmetry and power of dumbbells weights.

White, black, grey or rust colour finishes reinforce the solid look of the tables, and provide a contrast for the top's edge.

A selection of solid, resistant materials have been used for its construction, such as marine board, used in tops and bases and a lacquered steel foot.

The product is available in a wide variety of options, boasting four colours, a round or square top and five different heights.



DUMBBELL by Estudio Sancal, 2018



Mesas, tables





# TORTUGA

**La teoría de la evolución comienza en las Galápagos...** Podemos hablar de una evolución en toda regla, cuando **Isaac Piñeiro** propone unas mini butacaquitas y un sólido programa de mesas.

Las mesas de comedor recurren al sistema de construcción empleado en las patas de las butacas y las mesitas auxiliares. Se trata de un diseño de líneas muy limpias, atemporal y elegante, en el que la madera de fresno toma protagonismo a través de su vetada consistencia y la sutil estructura de metal aporta textura y perfila las líneas con su rotundo color negro. Los sobres de las mesas pueden ser redondos, con tres patas, o bien rectangulares con una pata en cada esquina. Existen dos medidas para cada opción. La pluralidad de combinaciones no solo reside en las medidas y formas de los sobres, sino también en la amplia carta de colores disponible.

De esta forma, la familia **Tortuga** se adapta mejor a todo tipo de ecosistemas. Los pufs y mesitas completan la colección.

**The theory of evolution started with the Galapagos tortoise...** The family continues to evolve and **Isaac** proposes some comfortable mini lounge chairs and solid tables.

The dining tables show the same design language used in the feet of the armchairs and auxiliary tables, with a familiar leg construction running through the collection. The product's clean lines focus attention on the ash wood's beautiful natural grain. The black metal structure, used throughout the range, acts as a design accent, outlining the shape of the feet. Choose between round table-tops with three legs, or rectangular with a leg in each corner. There are two sizes for each option. A wide variety of colours are also available, as per our chart.

And so, the **Tortuga** family adapts even better to its environment with a range of full-sized and mini lounge chairs. Poufs and side tables complete the collection.



TORTUGA by Isaac Piñeiro, 2018



Mesas, tables



# DUPLEX

La mesa de la cascada. **Dúplex** es la primera colaboración de **Sancal** con el estudio valenciano **MUT Design**. Se trata de una pequeña familia de mesitas auxiliares inspiradas en la arquitectura racional de Mies van der Rohe y Frank Lloyd Wright.

El juego arquitectónico alcanza su máximo desarrollo al superponer mesitas de distintas medidas, si bien todas las versiones tienen dos plantas en las que disponer de una amplia variedad de objetos y funcionalidades.

Las estructuras son de metal lacado y las tapas de chapa de fresno combinada con tableo marino. Las bandejas superiores son opcionales y combinables entre las distintas medidas. El colorido es tan amplio como nuestra actual carta de tintes y lacas.

The table from a waterfall. **Dúplex** is the first collection by **Sancal** with the Valencian studio **MUT Design**: a small range of occasional tables that have been inspired by the architecture of Mies van der Rohe and Frank Lloyd Wright.

The play on architecture reaches its climax when different tables of differing heights are placed over one another. But even without a partner, each table boasts two "floors" which can be used to display all manner of objects.

The metallic structures are lacquered and the marine plywood tops are veneered with ash.



DUPLEX by MUT Design, 2016



Mesas, tables



# VESPER

**Del río a la mesa.** La creación de **Sebastian Herkner** para **Sancal** es una familia de mesas muy funcional. Sus 4 alturas se adaptan a las necesidades de cada proyecto.

**Vesper** en alemán significa cena fría, por lo que además de la tradicional mesa de comedor, también funciona como mesa de comedor ocasional o bistró y como mesa de centro y auxiliar.

Como ya hiciera con **Talo**, **Sebastian** se inspira de nuevo en la naturaleza. Un innovador y flexible material, compuesto de piedra y resina, permite modelar las bases para emular un canto rodado. Las tapas también simulan las formas irregulares y caprichosas de la erosión.

**Fresh from the river.** The creation by **Sebastian Herkner** for **Sancal** is a functional family of tables with four heights to suit every project.

**Vesper** is German for a cold dinner reflecting the table's use both as a low occasional table or a dining table.

**Sebastian** was inspired by nature, just as he was with the **Talo** chair. He used an innovative and flexible material, made of stone and resin, to enable the bases to emulate the rounded edges of a pebble. The tops use the same substance to simulate the irregular edges formed by erosion.



VESPER by Sebastian Herkner, 2016



Mesas, tables



# PION

¡Jaque mate! **Ionna Vautrin** diseñó esta colorida familia de mesas y banquetas, inspirada por las figuras del ajedrez.

Como el famoso juego, **Pion** consta de una amplia gama de piezas. El rey y la reina estarían representados por las mesas de comedor y conferencia. Su belleza y singularidad serán objeto de atención allá donde estén, ya sea en una sala de juntas, un restaurante o un comedor. Las torres, los alfiles y los caballos encuentran su analogía en la legión de mesas auxiliares. Por último, el humilde peón al que no hay que subestimar, tomaría forma de banqueta. La piel de esta pequeña y robusta pieza ha sido cuidadosamente curtida para combinar su color con el de la base lacada. Se use en conjunto o por separado, **Pion** siempre da un toque de brillo a cualquier entorno.

Los acabados también juegan, esta vez, con los contrastes: el alto brillo de los lacados puede combinarse con piedra natural, madera o piel. Se trata de unas combinaciones cuidadosamente seleccionadas teniendo en cuenta el carácter y personalidad de cada una de las piezas.

**Checkmate!** **Ionna Vautrin** was inspired by a chess set when designing these colourful stools and tables.

The **Pion** is a complete set of pieces. The queens and kings are represented by the dining and conference tables. Flexible enough to be used in a range of situations, from a meeting room to a restaurant or living room, they command attention wherever they are placed. Rooks, bishops and knights can all find their analogies within a legion of occasional tables. And yet, the humble pawn, the stool, should not be overlooked. Small and robust, its leather seat has been carefully tanned to match the colour of the lacquered base. Used in concert, or as separate pieces, the **Pion** adds a touch of brilliance to any scenario.

The finishes play with contrasts: a high gloss lacquered base can be combined with natural stone, wood or leather in a carefully curated selection of configurations.







NUDO by Juan Ibáñez Lax, 2012



# NUDO

**Naturaleza en estado puro.** La familia de mesas **Nudo** nació como un pequeño programa auxiliar inspirado en la arbitrariedad de la naturaleza.

Gracias a un esmerado y artesanal trabajo de torno y talla, las patas, como si de ramas se tratara, simulan los nervios del tronco de un árbol. Con sus distintas alturas y diámetros podremos crear interesantes combinaciones y darles un uso alternativo. Asimismo, el banco es una pieza tan cálida como funcional, que puede resultar de gran utilidad en comercios, en un recibidor e, incluso, en un dormitorio.

El acabado de la madera simula las técnicas de encerado tradicional para respetar la nobleza de la materia prima y conseguir un tacto suave sin alterar la calidez del roble natural. Las mesitas redondas también están disponibles en mármol (blanco carrara y negro marquina).

**Inspired by nature.** **Nudo** is Spanish for the knots found in tree trunks. The collection started as a small collection of occasional tables inspired by nature.

The legs replicate the sinews of a tree-trunk, as if they were branches, thanks to painstaking lathing and carving. The lightness and wide variety of sizes and finishes enable the creation of interesting combinations, giving them alternative uses. The bench, for example, is warm yet functional and would be suitable for a shop, hallway or even a bedroom.

A special hard-wearing matt treatment gives the table a traditional wax-like finish, accentuating the natural grain of the solid oak top. The round tables are also available in marble (White Carrara and Black Marquina).



HE by Estudio Sancal, 2006



# HE

**He** combina un pie de acero cromado con un sobre redondo en chapa de roble mallado que puede ser tintado en una amplia gama de colores.

**He** combines a chrome steel foot with a round top. The table top is available in meshed oak, which can be stained in a variety of colours.



Mesas, tables

# ROCK

**Rock** es una familia de mesas inspirada en los años 50. Un proyecto expresivo y sensual para el que **Rafa García** se ha dejado influenciar por las formas orgánicas y biomorfas que popularizaron los precursores del diseño industrial. También esta disponible la versión **Rock** lacada con una luminosa selección de colorido. Así, junto a los ya habituales roble y espejo; las notas de esta partitura nos permitirán crear melodías personalizadas.

**Rock** is a small family of tables inspired by the abundance, exuberance and optimism of the '50s. **Rafa García** has been influenced by the organic and biomorphic forms which were popularized by the pioneers of industrial design. We introduce lacquered **Rock** - as a new version with a light palette of colours. Thus - together with the usual oak and mirror - the notes of this score will allow us to create personalized melodies.



# Accesorios

# Accessories





# ESTOLA

**Amor a primera vista.** Estola es un astuto y sencillo cojín que amplifica el confort de cualquier sofá y aporta un toque de color.

Su diseño está a medio camino entre un cojín y una mantita. Estola recibe su nombre por las solapas que caen a ambos lados del respaldo, las cuales facilitan que el cojín quede perfectamente ubicado. Estas solapas tienen una importante presencia, por ello la elección del tejido es fundamental.

Cuando nuestra directora de arte tuvo entre sus manos la colección **Point de Paul Smith para Maharam x Kvadrat**, supo que Estola era el producto perfecto para lucir sus singulares estampados sin recargar el ambiente. Estola también está disponible sin ningún tipo de estampado en el tejido Facet.

**Love at first sight.** Estola is an ingenious cushion that enhances the comfort of any sofa, adding a touch of colour.

Its fabric flaps sit either side of the sofas back cushion holding a padded headrest in place. This, combined with the special stitching and peculiar design, meant that a distinctive fabric with just the right weight had to be found.

When our art director was presented with the fabric **Point by Paul Smith for Maharam x Kvadrat** she knew she had found the ideal material. The fabric's elaborate pattern might be overwhelming for an entire sofa, but is perfect for this large cushion. Its structure enables it to perch on top of a cushion with ease. For those yearning a calmer option she also selected the plain fabric Facet.



# DEEP

Los cojines **Deep** ayudan a personalizar nuestro sofá, y lo adaptan a las necesidades de ergonomía y estética de cada usuario. Gracias a la profundidad del asiento, podremos añadir una amplia combinación de almohadones y así, combinar los cojines acolchados para los brazos, con las almohadas lumbares y los cojines-estola (con textiles de Paul Smith) para el cabezal; hasta conseguir un **Deep** único, hecho a nuestra medida.

The cushion **Deep** accessories can also be used to personalise the sofa, adapting to the ergonomic and aesthetic necessities of each user. Ample scatter cushions can be added to vary the deepness of the seat. Quilted arm cushions can be combined with lumbar supports and stole-like headrest cushions (with fabrics by Paul Smith) to create an infinite array of unique **Deeps**.



BANG! by Elena Castaño-López, 2014



## BANG!

**Impacto multicolor.** Combinaciones de tonos a priori imposibles junto a otras perfectamente coordinadas han sido seleccionadas con maestría. Con la serie de cojines **Bang!**, **Elena** pretende generar una explosión de color que deslumbré a nuestras retinas.

El diseño clásico de los delicados ribetes de pasamanería refuerza la ironía cromática. Los colores disponibles son: crema-manzana, yema-klein, blanco-musgo, limón-tabaco, caqui-purpura, toffee-turquesa, celeste, coral y perla.

**An explosion of colour.** It takes an expert to present seemingly impossible colour combinations with others that have been perfectly coordinated. **Elena's** studies in fine art have enabled her to create the **Bang!** cushions with a dazzling use of colour.

Classic trimmings adorn the edges of the piece, continuing the theme of contrasts, this time set against the avant-garde patterns themselves. Available in the following colour combinations: cream-apple, yolk-klein, snow-grass, lemon-earth, khaki-purple, toffee-turquoise, sky blue, coral or pearl.



MANDARINA by Elena Castaño-López, 2010



## MANDARINAS

By **Elena Castaño-López**. El proyecto **Mandarinas** toma prestadas técnicas de costura propias de la corsetería para dar lugar a una detallista colección de cojines de formas redondeadas.

The **Mandarins** borrows sewing techniques from the lingerie trade for a detailed collection of rounded cushions.





# TECNO



# TALO



# REW



# PARTY



# COJINES



Cojín puntas cosidas  
Cushion with stitched corners



Cojín con banda  
Cushion with band



Cojín  
Cushion

Cojines, cushions

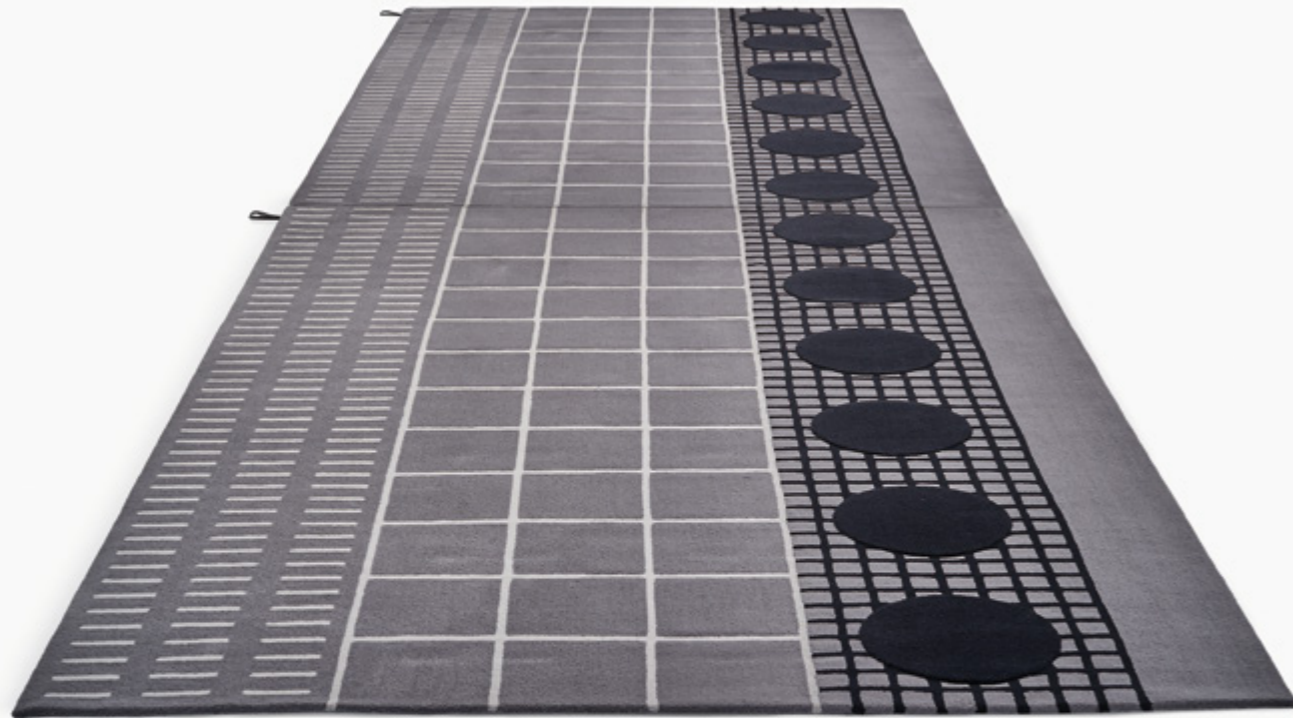

# MIND THE GAP

**Empezando con buen pie.** *Mind the Gap* es una cálida familia de alfombras que arropa al resto de diseños concebidos por el **Luca Nichetto** para amueblar unos sets inspirados por la estación milanesa **Turati**.

Se trata, además, de la primera incursión de **Sancal** en el mundo de las alfombras. Para este proyecto **Sancal** ha querido contar con la experiencia y el delicado saber hacer de uno de los telares más antiguos de España.

Realizadas en la lana virgen 100% natural por las expertas manos de un selecto equipo de artesanos mediante la técnica hand-tufting, las alfombras **Mind the Gap** se inspiran en los colores y la geometría que encontramos entre los andenes y galerías de la estación milanesa de **Turati**. El proceso de confección permite crear diseños muy precisos y generar diferentes alturas, lo que potencia los volúmenes del diseño. Una única medida de gran formato (200x300) y cinco versiones de color conforman esta mullida familia.

La vocación de esta pieza busca la calidez estética de cualquier espacio y prolongar hasta el infinito el juego de simetrías.

**A good way to start.** *Mind the Gap* is a range of warm rugs, a natural companion to the other three pieces of furniture products from the creative collaboration between **Nichetto Studio** and **Sancal**, inspired by **Milan's Turati** station.

The first incursion of the firm into this product category, **Mind the Gap** fills an empty space in **Sancal's** catalogue. For this project **Sancal** has counted on the experience and the delicate know-how of one of Spain's oldest looms.

Made of 100% pure virgin wool by the expert hands of a select team of artisans who use the tufting technique, **Mind the Gap** rugs are inspired by the geometry and colours of **Turati's** platform. The manufacturing process can create very precise designs and generate different heights, adding an extra dimension. The rug is available in one size (200x300) with five different colour combinations.

This piece brings warmth to any space and captivates with its seemingly infinite symmetries.

MIND THE GAP by **Nichetto Studio**, 2019

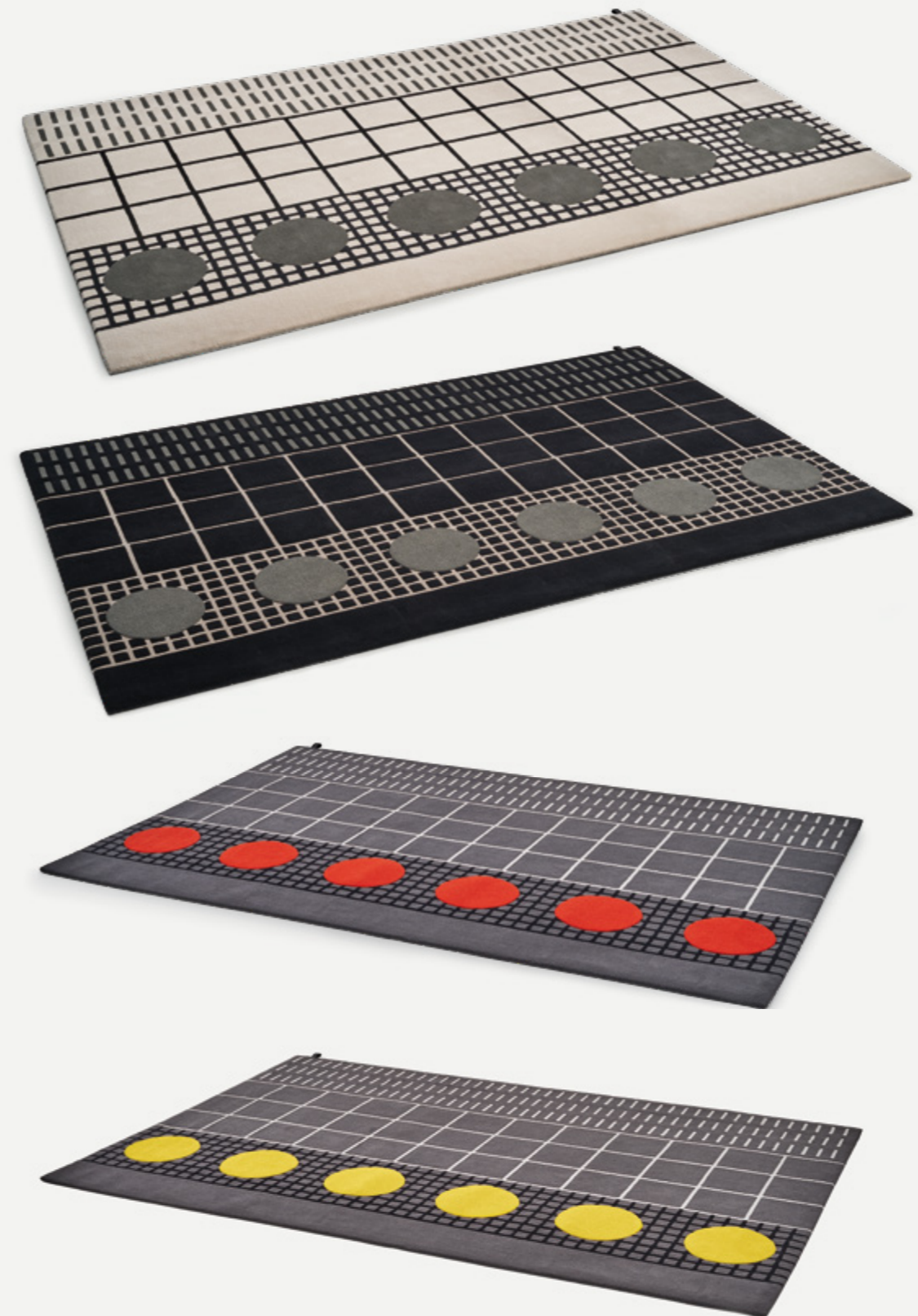

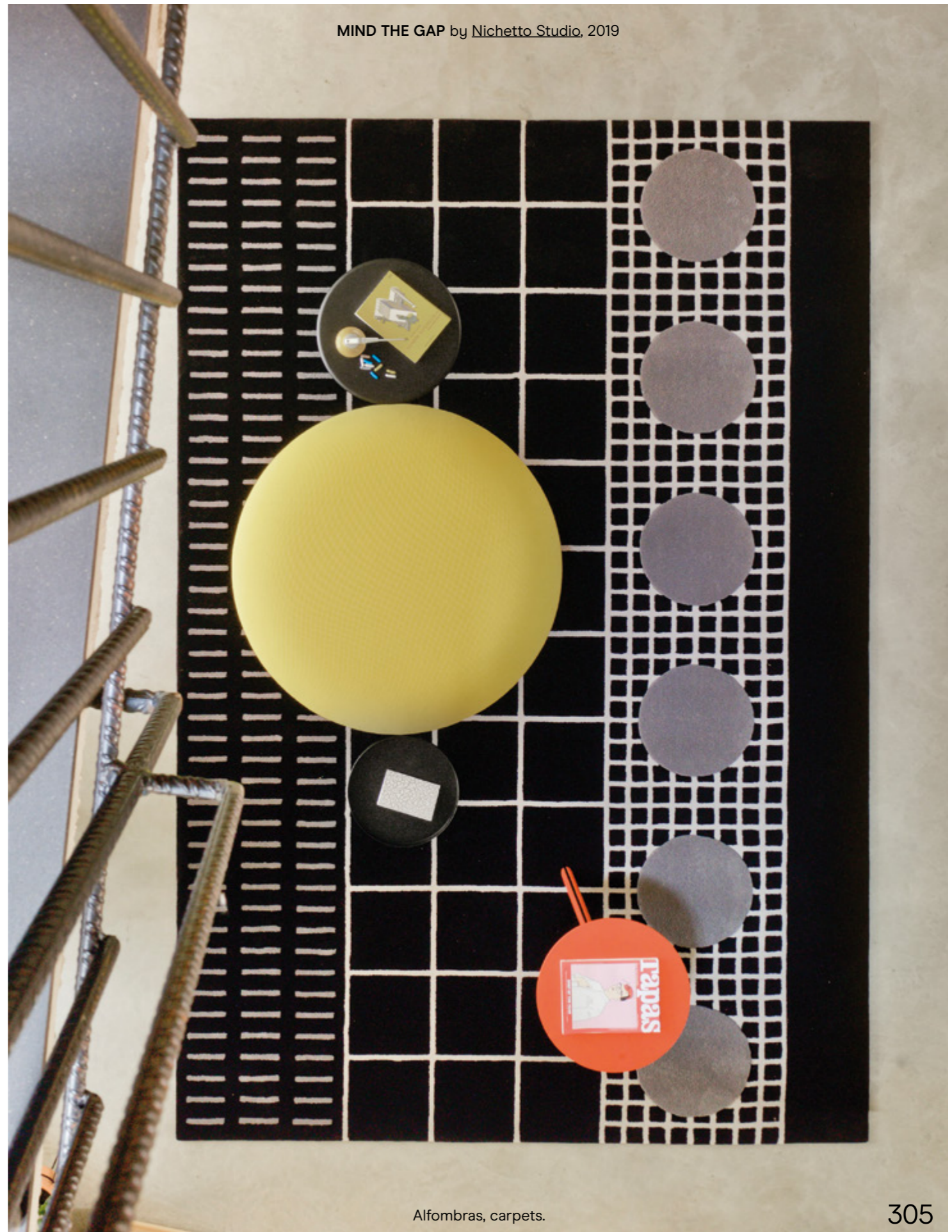

FLOAT by [Karim Rashid](#), 2012

# FLOAT

Estos escultóricos percheros han sido diseñados por **Karim Rashid** como una de las piezas más distintivas de la colección de asientos **Float**. Además de como colgadores integrados en el respaldo del sofá, es posible disponer de ellos de forma independiente a modo de perchero de pared. Gracias a un laborioso y artesanal trabajo de torno, el roble adquiere unas sugerentes formas redondeadas.

These sculptural hangers have been designed by **Karim Rashid** as one of the most distinctive items of the **Float** collection. They can be placed on the back of the sofa as well as a wall. Thanks to laborious handcrafted lathe work, the oak wood acquires suggestive rounded shapes.



Percheros, hooks



COSAS, lifestyle products by SANCAL

OBJETOS  
ORNAMENTS



JARRONES  
VASES



322.2.S.RC04  
FLOWER POWER RAW S CARMIN A04  
FLOWER POWER RAW S CARMINE A04



322.2.S.RP01  
FLOWER POWER RAW S PIEDRA A01  
FLOWER POWER RAW S STONE A01



322.2.S.RT02  
FLOWER POWER RAW S TOPO A02  
FLOWER POWER RAW S TAUPE A02



322.2.L.RM03  
FLOWER POWER RAW L MOSTAZA A03  
FLOWER POWER RAW L MUSTARD A03



322.2.L.RP01  
FLOWER POWER RAW L PIEDRA A01  
FLOWER POWER RAW L STONE A01



322.2.L.RT02  
FLOWER POWER RAW L TOPO A02  
FLOWER POWER RAW L TAUPE A02

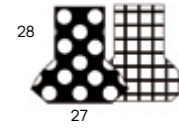

322.2.S.MO02  
FLOWER POWER S MONOCHROME 02  
FLOWER POWER S MONOCHROME 02



322.2.S.WD02  
FLOWER POWER S WILD DOTS 02  
FLOWER POWER S WILD DOTS 02



322.2.S.VA01  
FLOWER POWER S VALIENTE 01  
FLOWER POWER S VALIENTE 01

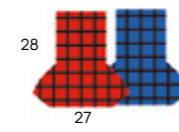

322.2.S.GR01  
FLOWER POWER S GRID 01  
FLOWER POWER S GRID 01

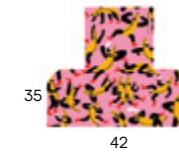

322.2.L.BG02  
FLOWER POWER L BANANA GUYS 02  
FLOWER POWER L BANANA GUYS 02

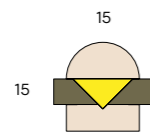

341.1.C  
ICONS BLOQUES DE MADERA  
DECORATIVOS CHEESEBURGUER  
ICONS ORNAMENTAL WOODEN  
BLOCKS CHEESEBURGUER

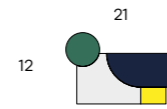

341.1.D  
ICONS BLOQUES DE MADERA  
DECORATIVOS DUCK  
ICONS ORNAMENTAL WOODEN  
BLOCKS DUCK

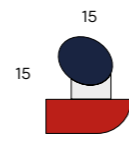

341.1.CS  
ICONS BLOQUES DE MADERA  
DECORATIVOS CONTAINER SHIP  
ICONS ORNAMENTAL WOODEN  
BLOCKS CONTAINER SHIP

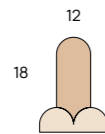

341.1.CB  
ICONS BLOQUES DE MADERA  
DECORATIVOS CASUS BELLI  
ICONS ORNAMENTAL WOODEN  
BLOCKS CASUS BELLI

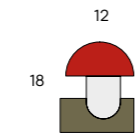

341.1.FA  
ICONS BLOQUES DE MADERA  
DECORATIVOS FLY AGARIC  
ICONS ORNAMENTAL WOODEN  
BLOCKS FLY AGARIC

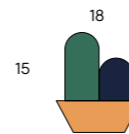

341.1.M  
ICONS BLOQUES DE MADERA  
DECORATIVOS MEXICO  
ICONS ORNAMENTAL WOODEN  
BLOCKS MEXICO

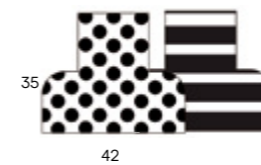

322.2.L.MO01  
FLOWER POWER L MONOCHROME 01  
FLOWER POWER L MONOCHROME 01

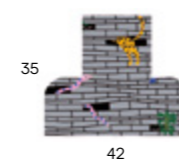

322.2.L.UJ02  
FLOWER POWER L URBAN JUNGLE 02  
FLOWER POWER L URBAN JUNGLE 02

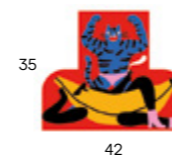

322.2.L.RE01  
FLOWER POWER L RELAX 01  
FLOWER POWER L RELAX 01

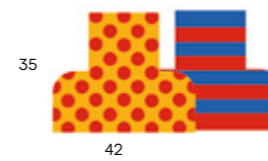

322.2.L.RU01  
FLOWER POWER L RUMBA 01  
FLOWER POWER L RUMBA 01



**COJINES  
CUSHIONS**

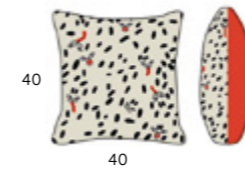

**323.22.EE.WD01**  
FLORA & FAUNA COJIN 40X40  
WILD DOTS 01 / PELO NARANJA  
FLORA & FAUNA CUSHION  
40X40 - WD01 / ORANGE FUR

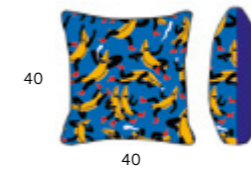

**323.22.EE.BG01**  
FLORA & FAUNA COJIN 40X40  
BANANA GUYS 01 / PELO AZUL  
FLORA & FAUNA CUSHION  
40X40 - BG01 / BLUE FUR

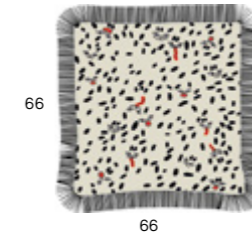

**323.22.GG.WD01**  
FLORA & FAUNA COJIN 66X66  
C/ FLECOS - WILD DOTS 01  
FLORA & FAUNA CUSHION  
66X66 W/FRINGES - WD01

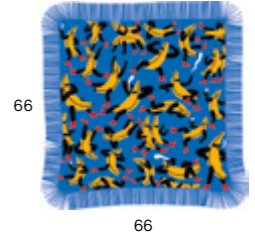

**323.22.GG.BG01**  
FLORA & FAUNA COJIN 66X66  
C/ FLECOS - BANANA GUYS 01  
FLORA & FAUNA CUSHION  
66X66 W/FRINGES - BG01

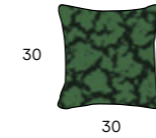

**324.22.DD.C1**  
RIFT COJIN 30X30 VERDE  
RIFT CUSHION 30X30 GREEN

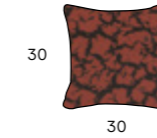

**324.22.DD.C2**  
RIFT COJIN 30X30 TEJA  
RIFT CUSHION 30X30 BRICK-RED

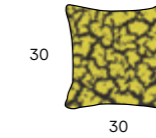

**324.22.DD.C3**  
RIFT COJIN 30X30 AMARILLO  
RIFT CUSHION 30X30 YELLOW

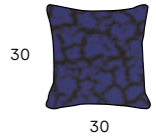

**324.22.DD.C4**  
RIFT COJIN 30X30 AZUL  
RIFT CUSHION 30X30 BLUE

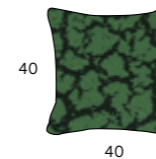

**324.22.EE.C1**  
RIFT COJIN 40X40 VERDE  
RIFT CUSHION 40X40 GREEN

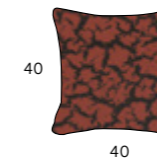

**324.22.EE.C2**  
RIFT COJIN 40X40 TEJA  
RIFT CUSHION 40X40 BRICK-RED

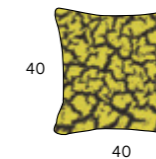

**324.22.EE.C3**  
RIFT COJIN 40X40 AMARILLO  
RIFT CUSHION 40X40 YELLOW

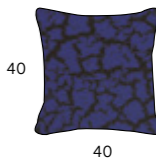

**324.22.EE.C4**  
RIFT COJIN 40X40 AZUL  
RIFT CUSHION 40X40 BLUE

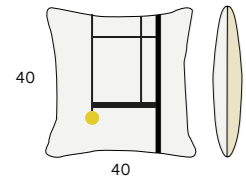

**310.22.C1L**  
C1-C4 COJIN 40X40 - C1 LANA  
C1-C4 CUSHION 40X40 - C1 WOOL

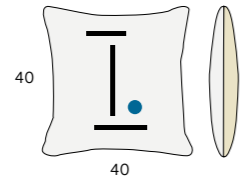

**310.22.21L**  
C1-C4 COJIN 40X40 - C2 LANA  
C1-C4 CUSHION 40X40 - C2 WOOL

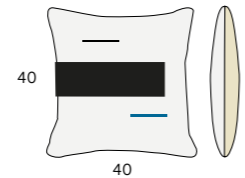

**310.22.C3L**  
C1-C4 COJIN 40X40 - C3 LANA  
C1-C4 CUSHION 40X40 - C3 WOOL

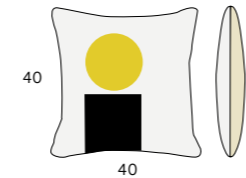

**310.22.C4L**  
C1-C4 COJIN 40X40 - C4 LANA  
C1-C4 CUSHION 40X40 - C4 WOOL

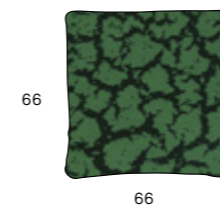

**324.22.GG.C1X**  
RIFT COJIN FINO 66X66 VERDE  
RIFT FLOPPY CUSHION 66X66 GREEN

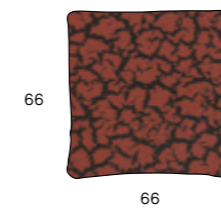

**324.22.GG.C2X**  
RIFT COJIN FINO 66X66 TEJA  
RIFT FLOPPY CUSHION  
66X66 BRICK-RED

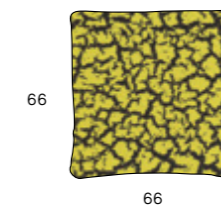

**324.22.GG.C3X**  
RIFT COJIN FINO 66X66 AMARILLO  
RIFT FLOPPY CUSHION  
66X66 YELLOW

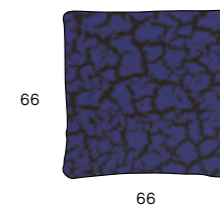

**324.22.GG.C4X**  
RIFT COJIN FINO 66X66 AZUL  
RIFT FLOPPY CUSHION 66X66 BLUE

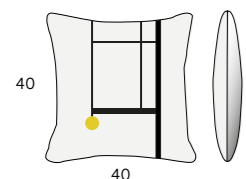

**310.22.C1P**  
C1-C4 COJIN 40X40 - C1 PIEL  
C1-C4 CUSHION 40X40 - C1 LEATHER

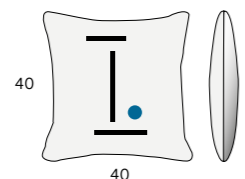

**310.22.C2P**  
C1-C4 COJIN 40X40 - C2 PIEL  
C1-C4 CUSHION 40X40 - C2 LEATHER

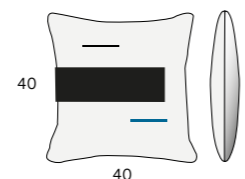

**310.22.C3P**  
C1-C4 COJIN 40X40 - C3 PIEL  
C1-C4 CUSHION 40X40 - C3 LEATHER

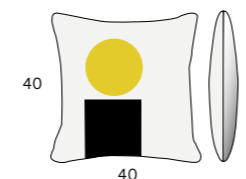

**310.22.C4P**  
C1-C4 COJIN 40X40 - C4 PIEL  
C1-C4 CUSHION 40X40 - C4 LEATHER

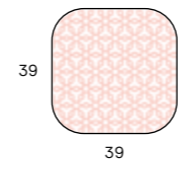

**352.22.101**  
CAIRO COJIN 101 SALMON  
CAIRO CUSHION 101 SALMON

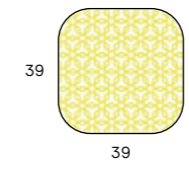

**352.22.102**  
CAIRO COJIN 102 PISTACHO  
CAIRO CUSHION 102 PISTACHIO

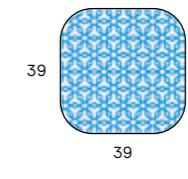

**352.22.103**  
CAIRO COJIN 103 AZUL  
CAIRO CUSHION 103 BLUE

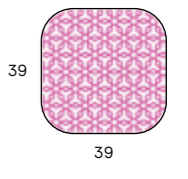

**352.22.104**  
CAIRO COJIN 104 FUCSIA  
CAIRO CUSHION 104 FUCHSIA

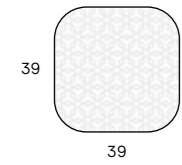

352.22.105  
CAIRO COJIN 105 GRIS  
CAIRO CUSHION 105 GREY

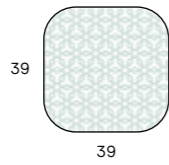

352.22.106  
CAIRO COJIN 106 VERDE  
CAIRO CUSHION 106 GREEN

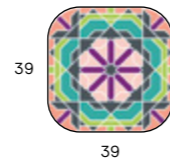

352.22.201  
CAIRO COJIN 201 CARAMELO  
CAIRO CUSHION 201 CAMEL

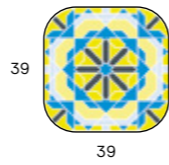

352.22.202  
CAIRO COJIN 202 LIMÓN  
CAIRO CUSHION 202 LEMON

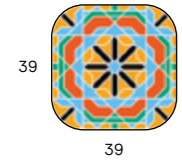

352.22.203  
CAIRO COJIN 203 FRUTA  
CAIRO CUSHION 203 FRUIT

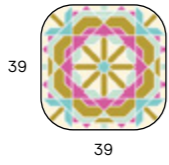

352.22.204  
CAIRO COJIN 204 VERANO  
CAIRO CUSHION 204 SUMMER

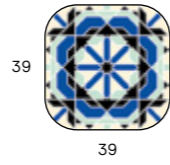

352.22.205  
CAIRO COJIN 201 MAR  
CAIRO CUSHION 201 SEA

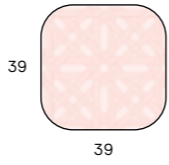

352.22.301  
CAIRO COJIN 301 SALMÓN  
CAIRO CUSHION 301 SALMON

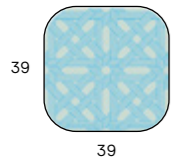

352.22.302  
CAIRO COJIN 302 TURQUESA  
CAIRO CUSHION 302 TURQUOISE

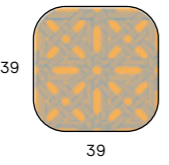

352.22.303  
CAIRO COJIN 303 NARANJA  
CAIRO CUSHION 303 ORANGE

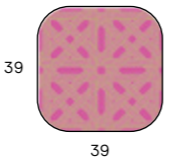

352.22.304  
CAIRO COJIN 304 FUCSIA  
CAIRO CUSHION 304 FUCHSIA

# MANTAS BLANKETS

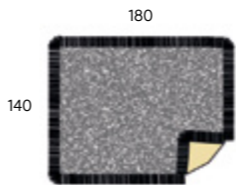

321.3M.L.MFN  
TÁPAME MUCHO L MONOCHROME  
TÁPAME MUCHO L MONOCHROME

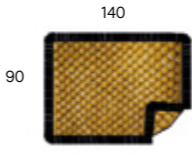

321.3M.S.BPA  
TÁPAME MUCHO S BUMPY AMARILLO  
TÁPAME MUCHO S BUMPY YELLOW

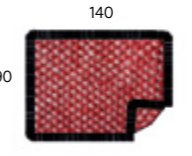

321.3M.S.BPR  
TÁPAME MUCHO S BUMPY ROJO  
TÁPAME MUCHO S BUMPY RED

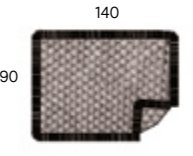

321.3M.S.BPG  
TÁPAME MUCHO S BUMPY GRIS  
TÁPAME MUCHO S BUMPY GREY

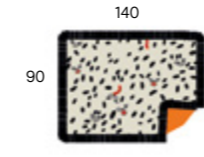

321.3M.S.WD01  
TÁPAME MUCHO S WILD DOTS BEIGE  
FLECO NEGRO  
TÁPAME MUCHO S BEIGE WILD DOTS  
BLACK FRINGZES

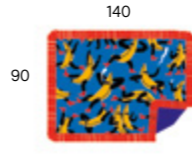

321.3M.S.BG01  
TÁPAME MUCHO S BANANA GUYS  
AZUL FLECO ROJO  
TÁPAME MUCHO S BLUE BANANA  
GUYS RED FRINGES

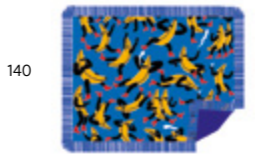

321.3M.L.BG01  
TÁPAME MUCHO L BANANA GUYS  
AZUL FLECO AZUL  
TÁPAME MUCHO L BLUE BANANA  
GUYS BLUE FRINGES

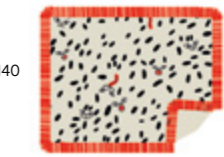

321.3M.L.WD01  
TÁPAME MUCHO L WILD DOTS BEIGE  
FLECO ROJO  
TÁPAME MUCHO L BEIGE WILD DOTS  
RED FRINGES

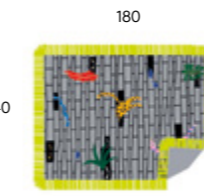

321.3M.L.UJ02  
TÁPAME MUCHO L URBAN JUNGLE GRIS  
FLECO AMARILLO  
TÁPAME MUCHO L GREY URBAN JUNGLE  
YELLOW FRINGES



326.3M.MM  
BORN FREE MINI MANTA ACOLCHADA  
119X116  
BORN FREE TINY QUILTED THROW  
119X116

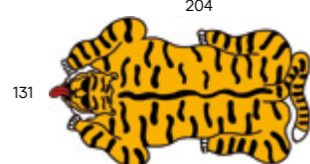

325.3M.PW  
LINDO GATITO MANTA  
ACOLCHADA 131X204  
LINDO GATITO QUILTED THROW  
131X204

# PERCHEROS HOOKS

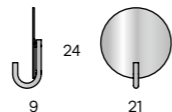

336.38.C.CR  
TAIL PERCHERO RADIANTE CROMO D21  
TAIL SHINY HOOK CHROME D21

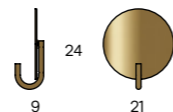

336.38.C.OR  
TAIL PERCHERO RADIANTE ORO D21  
TAIL SHINY HOOK GOLD D21

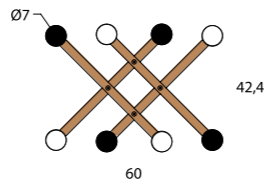

274.38.GE  
PAULI PERCHERO L  
PAULI WALL RACK L

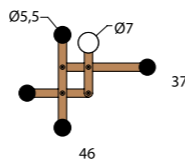

274.38.ED  
PAULI PERCHERO S  
PAULI WALL RACK S

**FUNDAS  
COVERS**



**CESTOS  
SACKS**



**340.3PN.XL.GY**  
FLOPPY CESTO XL GREY BRICKS  
FLOPPY SACK XL GREY BRICKS

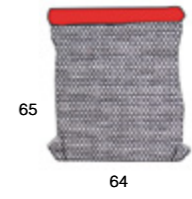

**340.3PN.XL.WH**  
FLOPPY CESTO XL WHITE BRICKS  
FLOPPY SACK XL WHITE BRICKS

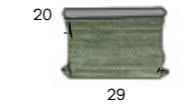

**340.3PN.S.LM**  
FLOPPY CESTO S LIMA BRICKS  
FLOPPY SACK S LIME BRICKS



**340.3PN.S.PH**  
FLOPPY CESTO S PEACH BRICKS  
FLOPPY SACK S PEACH BRICKS



**340.3PN.S.GY**  
FLOPPY CESTO S GREY BRICKS  
FLOPPY SACK S GREY BRICKS

**PAPELERÍA  
STATIONERY**



**339.00.GD**  
GEOMETRIC DOODLES  
PACK 3 LÁPICES  
GEOMETRIC DOODLES  
PACK 3 PENCILS

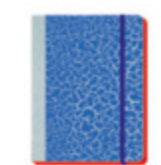

**337.A5.RFN**  
NOTES RIFT A5 LIBRETA  
NOTES RIFT A5 NOTEBOOK



**325.3M.PW**  
NOTES WILD DOTS A5 LIBRETA  
NOTES WILD DOTS A5 NOTEBOOK

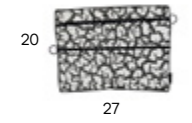

**324.3D.S.C5**  
RIFT FUNDA PROTECTORA S BLANCA  
RIFT COVER S WHITE

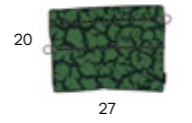

**324.3D.S.C1**  
RIFT FUNDA PROTECTORA S VERDE  
RIFT COVER S GREEN

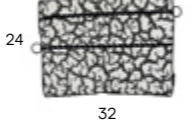

**324.3D.M.C5**  
RIFT FUNDA PROTECTORA M BLANCA  
RIFT COVER M WHITE



**324.3D.M.C1**  
RIFT FUNDA PROTECTORA M VERDE  
RIFT COVER M GREEN

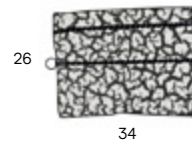

**324.3D.L.C5**  
RIFT FUNDA PROTECTORA L BLANCA  
RIFT COVER L WHITE

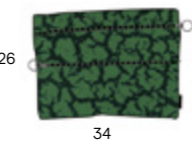

**324.3D.L.C1**  
RIFT FUNDA PROTECTORA L VERDE  
RIFT COVER L GREEN

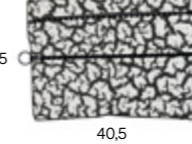

**324.3D.XL.C5**  
RIFT FUNDA PROTECTORA XL BLANCA  
RIFT COVER XL WHITE

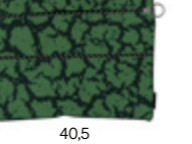

**324.3D.XL.C1**  
RIFT FUNDA PROTECTORA XL VERDE  
RIFT COVER XL GREEN



**337.A6.HVN**  
NOTES FROM HEAVEN  
PACK 2 A6 LIBRETAS  
NOTES FROM HEAVEN  
PACK 2 A6 NOTEBOOKS



**337.A6.HLL**  
NOTES FROM HELL  
PACK 2 A6 LIBRETAS  
NOTES FROM HELL  
PACK 2 A6 NOTEBOOKS

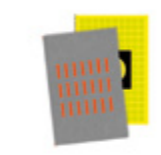

**337.A6.TRT**  
NOTES FROM TURATI  
PACK 2 A6 LIBRETAS  
NOTES FROM TURATI  
PACK 2 A6 NOTEBOOKS



**337.A6.SYH**  
NOTES FROM SEA & HILL  
PACK 2 A6 LIBRETAS  
NOTES FROM SEA & HILL  
PACK 2 A6 NOTEBOOKS



**BOLSOS  
BAGS**



**338.3MO.CCL**  
MOCHILA LBB CICLO  
BACKPACK LBB CYCLE



**338.3MO.CML**  
MOCHILA LBB CAMEL  
BACKPACK LBB CAMEL



**338.3MO.ONX**  
MOCHILA LBB ONIX  
BACKPACK LBB ONIX



**342.MO2.S.BN**  
SHOPPING BAG S BANANA  
SHOPPING BAG S BANANA



**327.3MO.APG01**  
SIN PISTOLS MOCHILA CENIZA  
SIN PISTOLS ASH BACKPACK



**327.3MO.APG02**  
SIN PISTOLS MOCHILA MARINO  
SIN PISTOLS NAVY BACKPACK



**327.3MO.APG03**  
SIN PISTOLS MOCHILA JEANS  
SIN PISTOLS JEANS BACKPACK

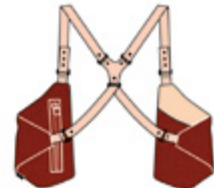

**327.3MO.APM01**  
SIN PISTOLS MOCHILA TEJA  
SIN PISTOLS BRICK BACKPACK



**327.3MO.ATN01**  
SIN PISTOLS MOCHILA CARBON  
SIN PISTOLS CARBON BACKPACK



**327.3MO.ATN02**  
SIN PISTOLS MOCHILA TOPO  
SIN PISTOLS TAUPE BACKPACK



**327.3MO.ATN03**  
SIN PISTOLS MOCHILA NIEVE  
SIN PISTOLS SNOW BACKPACK



**327.3MO.ATN04**  
SIN PISTOLS MOCHILA LIMON  
SIN PISTOLS LEMON BACKPACK



# Technical index

# Sofás Sofas

Alpino pag 26 - 27

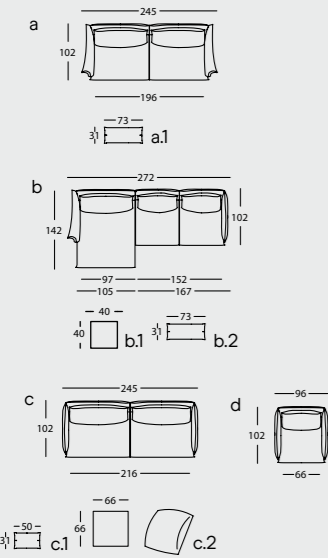

ID	UNI.	MOD.	DESCRIPCIÓN / DESCRIPTION	REF.	ACABADO FINISHES	TELAS / FABRICS		SERIES	MUESTRARIO SAMPLE
						ALMOHADA CUSHION	BASE		
a	1	ALPINO	SOFA 245 BR SOLAPA SOFA 245 ARM W/FLAP	331.11.V.BS	108 NEGRO	6115		6	115
a.1	1	ALPINO	COJIN 73X31 CUSHION 73X31	331.22.HD	-	PLECTO 444		9	FEBRIK KVADRAT
b	1	ALPINO	CHAISE 123X142 BR SOLAPA IZDO CHAISE LONGUE 123X142 LEFT ARM W/FLAP	331.14.L.BS.I	043 MANGO	7215		7	127
b	1	ALPINO	MOD 217 BR RECTO DCHO MOD 217 RIGHT PLAIN ARM	331.12.V.5.D	043 MANGO	7215		7	127
b.1	1	C1_C4	COJIN 40X40 PIEL CUSHION 40X40 LEATHER	310.22.C1P	-	-		-	-
b.2	1	ALPINO	COJIN 73X31 CUSHION 73X31	331.22.HD	-	ATLANTIC 63057		2	112
c	1	ALPINO	SOFA 245 BR RECTO SOFA 245 PLAIN ARM	331.11.X.5	002 NATURAL	2852		2	125
c.1	1	ALPINO	COJIN 50X31 CUSHION 50X31	331.22.FD	-	5005		5	122
c.2	1	C1_C4	COJIN 66x66 LANA CUSHION 66x66 WOOL	310.22.C3L	-	-		-	-
d	1	ALPINO	SILLON 95 BR RECTO ARMCHAIR 115 PLAIN ARM	331.11.G.5	043 MANGO	SOFT 05011		12	ELMO SOFT

Alpino pag 28 - 29

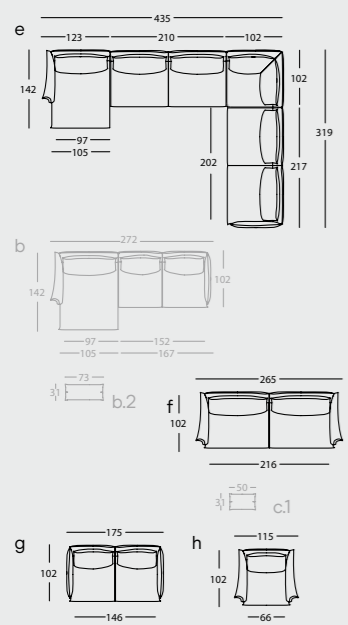

ID	UNI.	MOD.	DESCRIPCIÓN / DESCRIPTION	REF.	ACABADO FINISHES	TELAS / FABRICS		SERIES	MUESTRARIO SAMPLE
						ALMOHADA CUSHION	BASE		
e	1	ALPINO	CHAISE 123X142 BR SOLAPA IZDO CHAISE LONGUE 123X142 LEFT ARM W/FLAP	331.14.L.BS.I	043 MANGO	7215		7	127
e	1	ALPINO	MODULO 210 MODULE 210	331.12.V	043 MANGO	7215		7	127
e	1	ALPINO	ANGULO RECTO 102X102 CORNER 102X102	331.161.L	043 MANGO	7215		7	127
e	1	ALPINO	MOD 217 BR RECTO DCHO MOD 217 RIGHT PLAIN ARM	331.12.V.5.D	043 MANGO	7215		7	127
f	1	ALPINO	SOFA 265 BR SOLAPA SOFA 265 ARM W/FLAP	331.11.X.BS	002 NATURAL	5000		5	122
g		ALPINO	SOFA 175 BR RECTO SOFA 175 PLAIN ARM	331.11.S.5	003 NOGAL	3847		2	83
h	1	ALPINO	SILLON 115 BR SOLAPA ARMCHAIR 115 ARM W/FLAP	331.11.G.BS	108 NEGRO	6170		6	119

Alpino pag 30 - 31

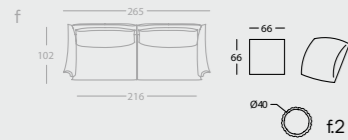

ID	UNI.	MOD.	DESCRIPCIÓN / DESCRIPTION	REF.	ACABADO FINISHES	TELAS / FABRICS		SERIES	MUESTRARIO SAMPLE
						ALMOHADA CUSHION	BASE		
f.1	1	RIFT	COJIN 66X66 FINO AMARILLO FLOPPY CUSHION 66X66 YELLOW	324.22.GG.C3X	-	-		-	-
f.2	1	BANG!	COJIN D40 BLANCO-MUSGO CUSHION D40 SNOW-GRASS	299.22.E.2	-	CODA 100 / STEP 68120		-	KVADRAT / 108

Alpino pag 32 - 33

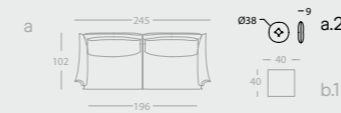

Alpino pag 34 - 35



Next Stop pag 36 - 37

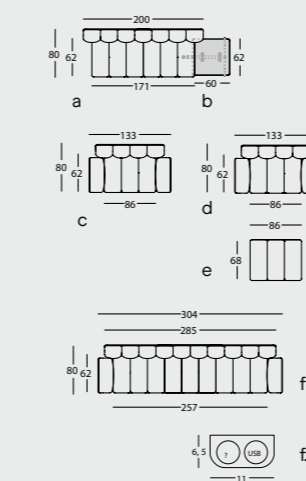

Next Stop pag 38 - 39

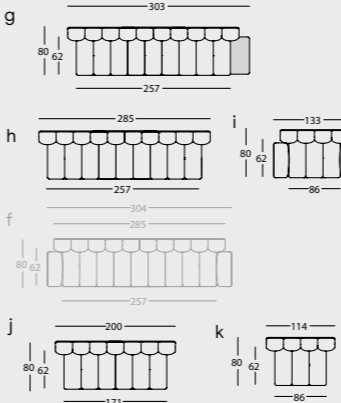

Next Stop pag 40 - 41

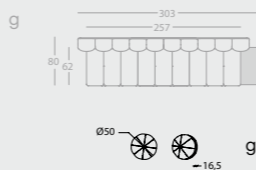

ID	UNI.	MOD.	DESCRIPCIÓN / DESCRIPTION	REF.	ACABADO FINISHES	TELAS / FABRICS		SERIES	MUESTRARIO SAMPLE
						ALMOHADA CUSHION	BASE		
a.2	1	PARTY	PARTY COJIN D38X9 PARTY CUSHION D38X9	277.24.D.W	-	1631 / 1636		4	101

ID	UNI.	MOD.	DESCRIPCIÓN / DESCRIPTION	REF.	ACABADO FINISHES	TELAS / FABRICS		SERIES	MUESTRARIO SAMPLE
						ALMOHADA CUSHION	BASE		
a	1	NEXT STOP	MODULO 200 NOGAL MODULE 200 WALNUT	328.12.X	002 NATURAL / 084 CROMO	ZERO YELLOW		11	ZERO
b	1	NEXT STOP	MESA TERMINAL NOGAL TERMINAL TABLE WALNUT	328.78.C	002 NATURAL / 084 CROMO	-		-	-
b	1	NEXT STOP	PIEZA UNIMODULOS LINKING PIECE	328.31.F	151 NEGRO	-		-	-
c	1	NEXT STOP	SILLON 133 ARMCHAIR 134	328.11.M	108 NEGRO / 151 NEGRO	ZERO PETROL		11	ZERO
d	1	NEXT STOP	SILLON 133 ARMCHAIR 133	328.11.M	108 NEGRO / 151 NEGRO	ZERO RUST RED		11	ZERO
e	1	NEXT STOP	BANCO 86 BENCH 86	328.10.J	108 NEGRO / 151 NEGRO	ZERO RUST RED		11	ZERO
f	1	NEXT STOP	SOFA 304	328.11.Z5	002 NATURAL / 151 NEGRO	ATLANTIC 64092		2	112
f.1	1	NEXT STOP	KIT ELECTICO MIXTO 1 BASE ENCHUFE + 1USB MIXED ELECTRIC SET 1 PLUG BASE + 1USB	328.2H.MIX	-	-		-	-

ID	UNI.	MOD.	DESCRIPCIÓN / DESCRIPTION	REF.	ACABADO FINISHES	TELAS / FABRICS		SERIES	MUESTRARIO SAMPLE
						ALMOHADA CUSHION	BASE		
g	1	NEXT STOP	MOD 285 C/MESA DCHO MOD 285 W/RIGHT TABLE	328.12.27.D	049 GRIS SEDA / 151 NEGRO	ZERO LIGHT GREY		11	ZERO
h	1	NEXT STOP	MODULO 285 MODULE 285	328.12.27	108 NEGRO / 151 NEGRO	ZERO MAUVE		11	ZERO
i	1	NEXT STOP	SILLON 133 NOGAL ARMCHAIR 133 WALNUT	328.11.M	002 NATURAL / 084 CROMO	ZERO YELLOW		11	ZERO
j	1	NEXT STOP	MODULO 200 MODULE 200	328.12.X	108 NEGRO / 151 NEGRO	6223		6	121
k	1	NEXT STOP	MODULO 114 MODULE 114	328.12.P	107 BLANCO / 151 NEGRO	6172		6	119

ID	UNI.	MOD.	DESCRIPCIÓN / DESCRIPTION	REF.	ACABADO FINISHES	TELAS / FABRICS		SERIES	MUESTRARIO SAMPLE
						ALMOHADA CUSHION	BASE		
g.1	2	MANDARINA	COJIN D40X14 FRUNCIDO WINKLED CUSHION D40X14	267.24.E.O	-	ATLANTIC 62049		2	112





Obi pag 70 - 71

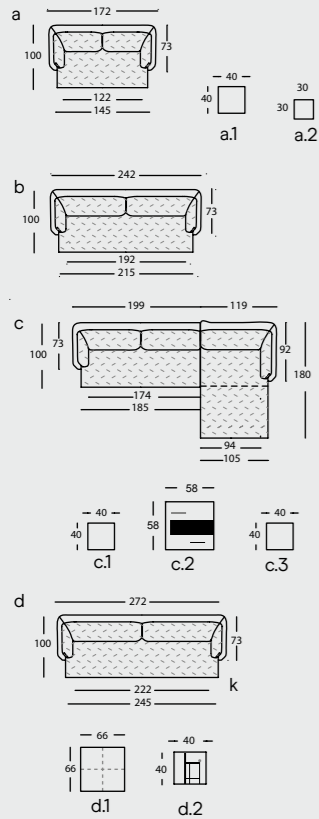

ID	UNI.	MOD.	DESCRIPCIÓN / DESCRIPTION	REF.	ACABADO FINISHES	TELAS / FABRICS ALMOHADA CUSHION BASE	SERIES	MUESTRARIO SAMPLE
a	1	Obi	SOFA 172 BR CORTO SOFA 172 SHORT ARM	306.11.T.3	052 KLEIN	STEP MELANGE 65011	3	108
a.1	1	COJIN CUSHION	COJIN DECORACION 40X40 CUSHION 40X40	100.22.DD	-	RAZZLE DAZZLE GINGER 466	9	FEBRIK KVADRAT
a.2	1	COJIN CUSHION	COJIN DECORACION 30X30 CUSHION 30X30	100.22.CC	-	STEP 65018	3	108
b	1	Obi	SOFA 242 BR CORTO SOFA 242 SHORT ARM	306.11.Z1.3	METACRILATO TRANSPARENT ACRYLIC	STEP 64159	3	108
c	1	Obi	MOD 199 BR CORTO IZDO MOD 199 SHORT LEFT ARM	306.12.V.3.I	METACRILATO TRANSPARENT ACRYLIC	UNIFORM MEL. BANANA 413	8	FEBRIK KVADRAT
c	1	Obi	CHAISE 119X180 BR DCHO CHAISE 119X180 RIGHT ARM	306.142. MU.3.D	METACRILATO TRANSPARENT ACRYLIC	UNIFORM MEL. BANANA 413	8	FEBRIK KVADRAT
c.1	1	COJIN CUSHION	COJIN DECORACION 40X40 CUSHION 40X40	100.22.DD	-	UNIFORM MEL. BANANA 413	8	FEBRIK KVADRAT
c.2	1	C1-C4	COJIN 58X58 - C3 LANA CUSHION 58X58 - C3 WOOL	310.22.C3L	-	-	-	-
c.3	1	COJIN CUSHION	COJIN DECORACION 40X40 CUSHION 40X40	100.22.DD	-	FACET 2 1001 6113	4	107.2
d	1	Obi	SOFA 272 BR CORTO SOFA 272 SHORT ARM	306.11.Z4.3	002 NATURAL	FACET 2 01 6113	4 / 6	107.2 / 115
d.1	1	COJIN CUSHION	COJIN DECORACION 66X66 CUSHION 66X66	100.22.GG	-	RAZZLE DAZZLE NATURAL 116	9	FEBRIK KVADRAT
d.2	1	C1-C4	COJIN 40X40 - C1 PIEL CUSHION 40X40 - C1 LEATHER	310.22.C1P	-	-	-	-

Obi pag 72 - 73

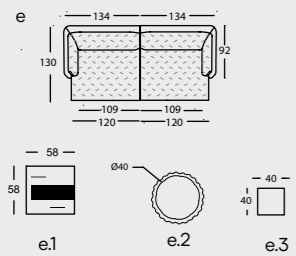

ID	UNI.	MOD.	DESCRIPCIÓN / DESCRIPTION	REF.	ACABADO FINISHES	TELAS / FABRICS ALMOHADA CUSHION BASE	SERIES	MUESTRARIO SAMPLE
e	1	Obi	CHAISE 134X130 BR IZDO CHAISE 134X130 LEFT ARM	306.142.PP.3.I	METACRILATO TRANSPARENT ACRYLIC	STEELCUT 2 535	8	KVADRAT
e	1	Obi	CHAISE 134X130 BR DCHO CHAISE 134X130 RIGHT ARM	306.142.PP.3.D	METACRILATO TRANSPARENT ACRYLIC	STEELCUT 2 535	8	KVADRAT
e.1	2	C1-C4	COJIN 58X58 - C3 LANA CUSHION 58X58 - C3 WOOL	310.22.C3L	-	-	-	-
e.2	1	BANG!	COJIN D40 BLANCO-MUSGO CUSHION D40 SNOW-GRASS	299.22.E.2	-	CODA 100 / STEP 68120	-	KVADRAT / 108
e.3	1	COJIN CUSHION	COJIN DECORACION 40X40 CUSHION 40X40	100.22.DD	-	6113	6	115

Tonella pag74 - 75

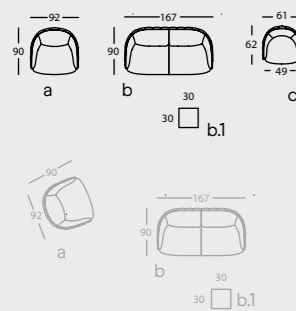

ID	UNI.	MOD.	DESCRIPCIÓN / DESCRIPTION	REF.	ACABADO FINISHES	TELAS / FABRICS ALMOHADA CUSHION BASE	SERIES	MUESTRARIO SAMPLE
a	1	TONELLA	SILLON 92 ACOLCHADO QUILTED ARMCHAIR 92	301.61.K	104 BRONCE	8068 STEP 63075	7 / 3	116 / 108
b	1	TONELLA	SOFA 167 ACOLCHADO QUILTED SOFA 167	301.61.T	103 NACAR	6114	6	115
b.1	1	COJIN CUSHION	COJIN DECORACION 30X30 CUSHION 30X30	100.22.CC	-	STEP 65018	3	108
c	1	TONELLA	BUTACA ACOLCHADA QUILTED MINI ARMCHAIR	301.51.G	103 NACAR	ATLANTIC 64092	2	112

Tonella pag 76 - 77

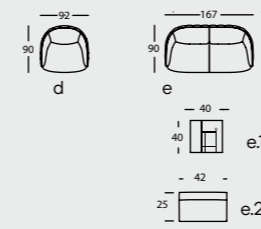

Tiptoe pag 78 - 79

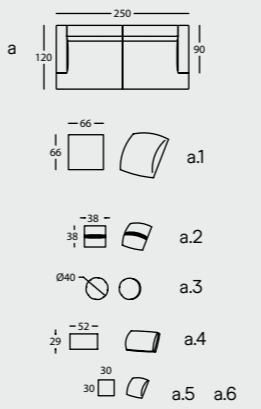

ID	UNI.	MOD.	DESCRIPCIÓN / DESCRIPTION	REF.	ACABADO FINISHES	TELAS / FABRICS ALMOHADA CUSHION BASE	SERIES	MUESTRARIO SAMPLE
d	1	TONELLA	SILLON 92 ACOLCHADO QUILTED ARMCHAIR 92	301.61.K	103 NACAR	1643	4	101
e	1	TONELLA	SOFA 167 ACOLCHADO QUILTED SOFA 167	301.61.T	104 BRONCE	6253	6	126
e.1	1	C1-C4	COJIN 40X40 - C2 PIEL CUSHION 40X40 - C2 LEATHER	310.22.C2P	-	-	-	-
e.2	1	TALO	COJIN CUSHION	290.23	-	GALAXY 408	7	KVADRAT

ID	UNI.	MOD.	DESCRIPCIÓN / DESCRIPTION	REF.	ACABADO FINISHES	TELAS / FABRICS ALMOHADA CUSHION BASE	SERIES	MUESTRARIO SAMPLE
a	1	TIPTOE	CHAISE 125X120 BR IZDO CHAISE 125X120 LEFT ARM	303.142.NN.I	087 COBRE	6110	6	114
a	1	TIPTOE	CHAISE 125X120 BR DCHO CHAISE 125X120 RIGHT ARM	303.142.NN.D	087 COBRE	6110	6	114
a.1	2	COJIN CUSHION	COJIN DECORACION 66X66 CUSHION 66X66	100.22.GG	-	6110	6	114
a.2	1	REW	COJIN 38X38 CUSHION 38X38	292.22.DD	-	1643	4	101
a.3	1	BANG!	COJIN D40 CREMA-MANZANA CUSHION D40 CREAM-APPLE	299.22.E.1	-	CODA 422 / STEP 68118	-	KVADRAT / 108
a.4	1	TEA	ALMOHADA RIÑONERA LUMBAR CUSHION	250.27	-	805 CHESTNUT	12	CLASSIC 2
a.5	1	COJIN CUSHION	COJIN DECORACION 30X30 CUSHION 30X30	100.22.CC	-	6103	6	114
a.6	1	COJIN CUSHION	COJIN DECORACION 30X30 CUSHION 30X30	100.22.CC	-	6101	6	114
b	1	TIPTOE	SOFA 220 BR CORTO SOFA 220 SHORT ARM	303.11.Y.2	086 GRAFITO	817 PERLA	12	CLASSIC 2
c	1	TIPTOE	SOFA 250 BR LARGO SOFA 250 LONG ARM	303.11.Z2.4	087 COBRE	STEELCUT 2 655	8	KVADRAT
d	1	TIPTOE	CHAISE 110X170 BR ALTO IZDO CHAISE 110X170 HIGH LEFT ARM	303.142.MT.3.I	086 GRAFITO	MEMORY 2 976	8	KVADRAT
d	1	TIPTOE	MOD 200 BR CORTO DCHO MOD 200 SHORT RIGHT ARM	303.12.W.2.D	086 GRAFITO	MEMORY 2 976	8	KVADRAT

Tiptoe pag 80 - 81

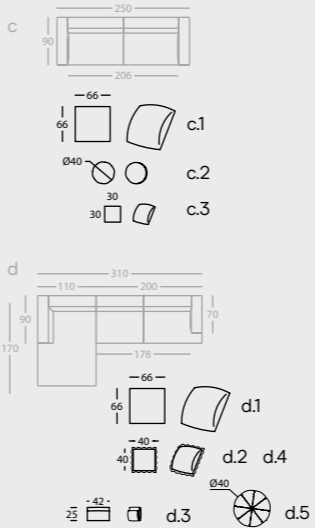

ID	UNI.	MOD.	DESCRIPCIÓN / DESCRIPTION	REF.	ACABADO FINISHES	TELAS / FABRICS ALMOHADA CUSHION BASE	SERIES	MUESTRARIO SAMPLE
c.1	1	COJIN CUSHION	COJIN DECORACION 66X66 CUSHION 66X66	100.22.GG	-	FACET 2 01	4	107.2
c.2	1	COJIN CUSHION	COJIN DECORACION 40X40 CUSHION 40X40	100.22.DD	-	910187	10	L-5
c.3	1	BANG!	COJIN D40 CORAL CUSHION D40 CORAL	299.22.E.3	-	CODA 2 632 / 3886	-	KVADRAT / 102
d.1	1	COJIN CUSHION	COJIN DECORACION 66X66 CUSHION 66X66	100.22.GG	-	6110	6	114
d.2	1	BANG!	COJIN 40X40 LIMON-TABACO CUSHION 40X40 LEMON-EARTH	299.22.EE.2	-	CODA 222 / STEP 61103	-	KVADRAT / 108
d.3	1	TALO	COJIN CUSHION	290.23	-	STEP 65018	3	108
d.4	1	BANG!	COJIN 40X40 CAQUI-PURPURA CUSHION 40X40 KHAKI-PURPLE	299.22.EE.3	-	CODA 222 / STEP 65047	-	KVADRAT / 108
d.5	1	MANDARINA	COJIN D40X14 FRUNCIDO WINKLED CUSHION D40X14	267.24.E.O	-	STEELCUT 2 605	8	KVADRAT



Copla pag 98 - 99

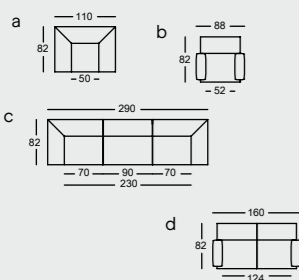

ID	UNI.	MOD.	DESCRIPCIÓN / DESCRIPTION	REF.	ACABADO FINISHES	TELAS / FABRICS ALMOHADA CUSHION BASE	SERIES	MUESTRARIO SAMPLE
a	1	COPLA	SILLON 110 BR ALTO ARMCHAIR 110 HIGH ARM	278.11.M.3	002 NATURAL	2810	3	118
b	1	COPLA	SILLON 88 BR BAJO ARMCHAIR 88 LOW ARM	278.11.J.J	002 NATURAL	STEP 67007	3	108
c	1	COPLA	SOFA 290 BR ALTO SOFA 290 HIGH ARM	278.11.Z.6.3	MANGO	STEP 63012	3	108
d	1	COPLA	SOFA 160 BR BAJO SOFA 160 LOW ARM	278.11.R.J	002 NATURAL	6258	6	126

Copla pag 100 - 101

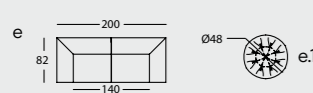

ID	UNI.	MOD.	DESCRIPCIÓN / DESCRIPTION	REF.	ACABADO FINISHES	TELAS / FABRICS ALMOHADA CUSHION BASE	SERIES	MUESTRARIO SAMPLE
e	1	COPLA	SOFA 200 BR ALTO SOFA 200 HIGH ARM	278.11.W.3	002 NATURAL	STEELCUT TRIO 3 205	8	KVADRAT
e.1	1	MANDARINA	COJIN Ø48X11.5 CON PELLIZCOS CUSHION Ø48X11.5 WITH PINCHES	267.24.E.P	-	STEP 64159	3	108

Folk pag 102 - 103

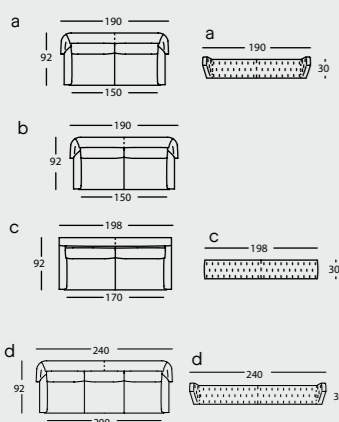

ID	UNI.	MOD.	DESCRIPCIÓN / DESCRIPTION	REF.	ACABADO FINISHES	TELAS / FABRICS ALMOHADA CUSHION BASE	SERIES	MUESTRARIO SAMPLE
a	1	FOLK	SOFÁ OREJERO 190 WING SOFA 190	269.11.U.R	003 NOGAL	6160	6	117
a	1	FOLK	FUNDA CABEZAL SOFA OREJERO 190 HEADREST COVER WING SOFA 190	269.35.U.R	-	6160	6	117
b	1	FOLK	SOFÁ OREJERO 190 WING SOFA 190	269.11.U.R	003 NOGAL	2802	3	118
c	1	FOLK	SOFÁ 198 SOFA 198	269.11.V.5	002 NATURAL	1643	4	101
c	1	FOLK	FUNDA CABEZAL SOFÁ 198 HEADREST COVER SOFA 198	269.35.V.5	-	1643	4	101
d	1	FOLK	SOFÁ OREJERO 240 WING SOFA 240	269.11.Z.R	002 NATURAL	FACET 45	4	107.2
d	1	FOLK	FUNDA CABEZAL SOFÁ OREJERO 240 HEADREST COVER WING SOFA 240	269.35.Z.R	-	FACET 45	4	107.2

Folk pag 104 - 105

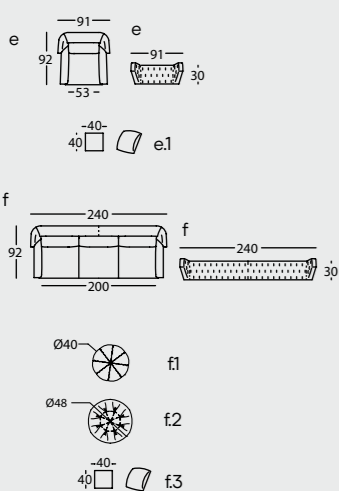

ID	UNI.	MOD.	DESCRIPCIÓN / DESCRIPTION	REF.	ACABADO FINISHES	TELAS / FABRICS ALMOHADA CUSHION BASE	SERIES	MUESTRARIO SAMPLE
e	1	FOLK	SILLON OREJERO WING ARMCHAIR	269.11.K.R	002 NATURAL	ATLANTIC 65037 / FACET 2 272	2 / 4	112 / 107.2
e	1	FOLK	FUNDA CABEZAL SILLON OREJERO HEADREST COVER WING ARMCHAIR	269.35.K.R	-	FACET 2 72	4	107.2
e.1	1	COJIN CUSHION	COJIN DECORACIÓN 40X40 CUSHION 40X40	100.22.DD	-	6157	6	117
f	1	FOLK	SOFÁ OREJERO 240 WING SOFA 240	269.11.Z.R	002 NATURAL	1631	4	101
f	1	FOLK	FUNDA CABEZAL SOFÁ OREJERO 240 HEADREST COVER WING SOFA 240	269.35.Z.R	-	1631	4	101
f.1	1	MANDARINA	COJIN D40X14 FRUNCIDO WINKLED CUSHION D40X14	267.24.E.O	-	ATLANTIC 64093	2	112
f.2	1	MANDARINA	COJIN D48X11,5 CON PELLIZCOS CUSHION D48X11,5 WITH PINCHES	267.24.E.P	-	ATLANTIC 66086	2	112
f.3	1	COJIN CUSHION	COJIN DECORACIÓN 40X40 CUSHION 40X40	100.22.DD	-	ATLANTIC 62048	2	102

Float pag 106 - 107

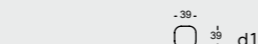
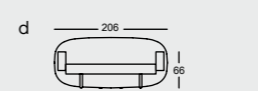
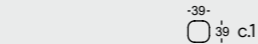
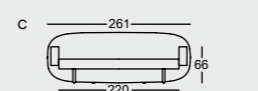
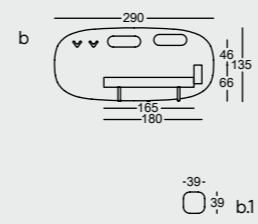
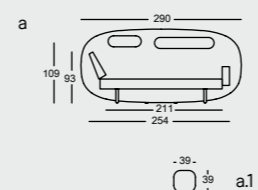

Float pag 108 - 109

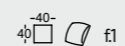
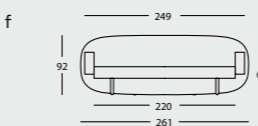
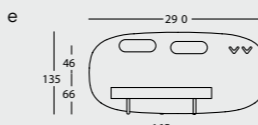

ID	UNI.	MOD.	DESCRIPCIÓN / DESCRIPTION	REF.	ACABADO FINISHES	TELAS / FABRICS ALMOHADA CUSHION BASE	SERIES	MUESTRARIO SAMPLE
a	1	FLOAT	RESPALDO 290 BACK 290	281.1A.Z6	049 GRIS SEDA	FACET 2 1000	4	107.2
a	1	FLOAT	ASIENTO 220 SEAT 220	281.1B.Y	049 GRIS SEDA	STEP MELANGE 68119	3	108
a	1	FLOAT	BRAZO INCLINADO IZDO INCLINED LEFT ARM	281.13A.I	-	ATLANTIC 67030	2	112
a	1	FLOAT	BRAZO LARGO DCHO LONG RIGHT ARM	281.135.D	-	ATLANTIC 67030	2	112
a	1	FLOAT	CABEZAL CORTO IZDO LEFT SHORT HEADBOARD	281.251.I	-	CAIRO 105	5	CAIRO
a	1	FLOAT	CABEZAL LARGO DCHO RIGHT LARGE HEADBOARD	281.252.D	-	CAIRO 301	5	CAIRO
a.1	1	FLOAT	COJIN 39X39 CUSHION 39X39	281.22.DD	-	CAIRO 201	5	CAIRO
b	1	FLOAT	RESPALDO 290 CON PERCHERO IZDO BACK 290 WITH LEFT HANGER	281.1A.Z6.P.I	002 NATURAL	STEELCUT TRIO 3 266	8	KVADRAT
b	1	FLOAT	ASIENTO 165 SEAT 165	281.1B.S	002 NATURAL	6109	6	114
b	1	FLOAT	BRAZO LARGO DCHO LONG RIGHT ARM	281.135.D	-	STEP 68118	3	108
b	1	FLOAT	CABEZAL CORTO IZDO LEFT SHORT HEADBOARD	281.251.I	-	CAIRO 103	5	CAIRO
b	1	FLOAT	CABEZAL CORTO DCHO RIGHT SHORT HEADBOARD	281.251.D	-	CAIRO 302	5	CAIRO
b.1	1	FLOAT	COJIN 39X39 CUSHION 39X39	281.22.DD	-	CAIRO 205	5	CAIRO
c	1	FLOAT	SOFA 261 SOFA 261	281.11.Z3	004 CENIZA	STEP MELANGE 60021	3	108
c.1	1	FLOAT	COJIN 39X39 CUSHION 39X39	281.22.DD	-	CAIRO 106	5	CAIRO
d	1	FLOAT	RESPALDO 206 BACK 206	281.1A.W	002 NATURAL	STEP 61103	3	108
d	1	FLOAT	ASIENTO 165 SEAT 165	281.1B.W	002 NATURAL	STEP 60011	3	108
d	1	FLOAT	BRAZO CORTO IZDO SHORT LEFT ARM	281.136.I	-	FACET 2 1008	4	107.2
d	1	FLOAT	BRAZO CORTO DCHO SHORT RIGHT ARM	281.136.D	-	STEP 60004	3	108
d.1	1	FLOAT	COJIN 39X39 CUSHION 39X39	281.22.DD	-	CAIRO 106	5	CAIRO

ID	UNI.	MOD.	DESCRIPCIÓN / DESCRIPTION	REF.	ACABADO FINISHES	TELAS / FABRICS ALMOHADA CUSHION BASE	SERIES	MUESTRARIO SAMPLE
e	1	FLOAT	RESPALDO 290 CON PERCHERO. DCHO BACK 290 WITH RIGHT HANGER	281.1A.Z6.P.D	042 AMARILLO	FACET 2 1000	4	107.2
e	1	FLOAT	ASIENTO 165 SEAT 165	281.1B.S	042 AMARILLO	ATLANTIC 60011	2	112
e	1	FLOAT	CABEZAL CORTO IZDO LEFT SHORT HEADBOARD	281.251.I	-	6112	6	115
e	1	FLOAT	CABEZAL CORTO DCHO RIGHT SHORT HEADBOARD	281.251.D	-	CAIRO 105	5	CAIRO
e.1	1	FLOAT	COJIN 39X39 CUSHION 39X39	281.22.DD	-	CAIRO 202	5	CAIRO
f	1	FLOAT	RESPALDO 261 BACK 261	281.1A.Z3	-	ATLANTIC 62049	2	112
f	1	FLOAT	ASIENTO 220 SOFA 261 SEAT 220 SOFA 261	281.1B.Z3	-	ATLANTIC 62049	2	112
f	1	FLOAT	BRAZO CORTO IZDO SHORT LEFT ARM	281.136.I	-	FACET 2 1000	4	107.2
f	1	FLOAT	BRAZO CORTO DCHO SHORT RIGHT ARM	281.136.D	-	FACET 2 1000	4	107.2
f.1	1	RIFT	COJIN 40X40 VERDE CUSHION 40X40 GREEN	324.22.EE.C1	-	-	-	-



Tea pag 110 - 111

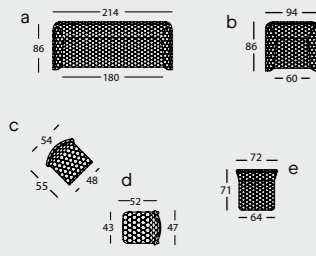

ID	UNI.	MOD.	DESCRIPCIÓN / DESCRIPTION	REF.	ACABADO FINISHES	TELAS / FABRICS ALMOHADA CUSHION BASE	SERIES	MUESTRARIO SAMPLE
a	1	TEA	SOFA 174 ACOLCHADO QUILTED SOFA 174	250.61.T.G	-	STEELCUT 2 820	8	KVADRAT
b	1	TEA	SILLON 94 ACOLCHADO QUILTED ARMCHAIR 94	250.61.K.G	-	FACET 2 72	4	107.2
c	1	TEA	TABURETE ACOLCHADO ROBLE QUILTED STOOL WITH OAK FEET	250.46.G	049 GRIS SEDA	MEMORY 2 936	8	KVADRAT
d	1	TEA	SILLA ACOLCHADA QUILTED CHAIR	250.41.G	-	STEP 66018 / FACET 2 45	3/4	108/107.2
e	1	TEA	BUTACA ACOLCHADA QUILTED SMALL ARMCHAIR	250.51.G	-	NITTO 857	7	FEBRIK KVADRAT

Tea pag 112 - 113

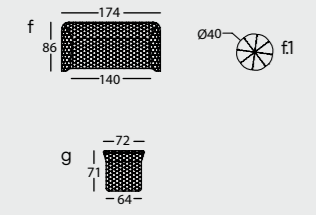

ID	UNI.	MOD.	DESCRIPCIÓN / DESCRIPTION	REF.	ACABADO FINISHES	TELAS / FABRICS ALMOHADA CUSHION BASE	SERIES	MUESTRARIO SAMPLE
f	1	TEA	SOFA 174 ACOLCHADO QUILTED SOFA 174	250.61.T.G	-	FACET 2 72	4	107.2
f.1	1	MANDARINA	COJIN D40X14 FRUNCIDO WINKLED CUSHION D40X14	267.24.E.O	-	ATLANTIC 64093	2	112
g	1	TEA	BUTACA ACOLCHADA QUILTED SMALL ARMCHAIR	250.51.G	-	ATLANTIC 64117 / MEMORY 2 236	2/8	112 / KVADRAT

Happen pag 114 - 115

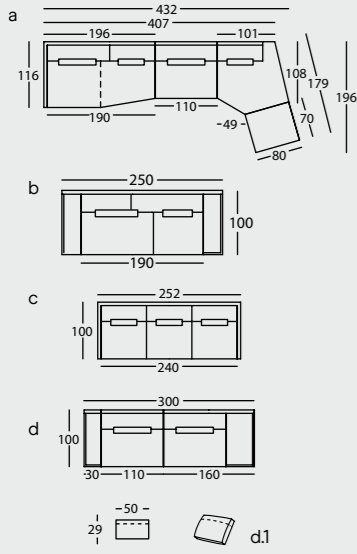

ID	UNI.	MOD.	DESCRIPCIÓN / DESCRIPTION	REF.	ACABADO FINISHES	TELAS / FABRICS ALMOHADA CUSHION BASE	SERIES	MUESTRARIO SAMPLE
a	1	HAPPEN	MOD. DOBLE FONDO 196 BRAZO ESTRECHO IZDO ALTO 74 MOD. 196 DOUBLE DEPTH NARROW LEFT ARM HIGH 74	256.122.VH.2Q.I	-	PLANUM 521	8	FEBRIK KVADRAT
a	1	HAPPEN	MODULO 110 ALTO 74 MODULE 110 HIGH 74	256.121.MH	-	PLANUM 521	8	FEBRIK KVADRAT
a	1	HAPPEN	MODULO TERMINAL 126 DCHO ALTO 74 RIGHT TERMINAL MODULE 126 HIGH 74	256.17.NH.D	-	PLANUM 521	8	FEBRIK KVADRAT
a	1	HAPPEN	PUF 80X70 POUF 80X70	256.151.JH	-	PLANUM 521	8	FEBRIK KVADRAT
b	1	HAPPEN	SOFA 250 BRAZO ANCHO ALTO 74 SOFA 250 WIDE ARM HIGH 74	256.11.Z2H.1	-	6112	6	115
c	1	HAPPEN	SOFA 252 BRAZO ESTRECHO ALTO 74 SOFA 252 NARROW ARM HIGH 74	256.11.Z2H.2	-	2852	2	125
d	1	HAPPEN	BRAZO ANCHO IZDO WIDE LEFT ARM	256.131.I	-	STEP 61149	3	108
d	1	HAPPEN	MODULO 110 ALTO 74 MODULE 110 HIGH 74	256.121.MH	-	STEP 61149	3	108
d	1	HAPPEN	MODULO 160 BRAZO BAJO DCHO ALTO 74 MODULE 160 LOW RIGHT ARM HIGH 74	256.122.SH.J.D	-	STEP 61149	3	108
d.1	2	HAPPEN	ALMOHADA RIÑONERA 50X29 LUMBAR CUSHION 50X29	256.27.FC	-	6215	6	121

Happen pag 116 - 117

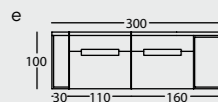

ID	UNI.	MOD.	DESCRIPCIÓN / DESCRIPTION	REF.	ACABADO FINISHES	TELAS / FABRICS ALMOHADA CUSHION BASE	SERIES	MUESTRARIO SAMPLE
e	1	HAPPEN	BRAZO ANCHO IZDO WIDE LEFT ARM	256.131.I	-	6251	6	126
e	1	HAPPEN	MODULO 110 ALTO 74 MODULE 110 HIGH 74	256.121.MH	-	6251	6	126
e	1	HAPPEN	MODULO MESA 160 DCHO ALTO 74 MODULE TABLE 160 RIGHT HIGH 74	256.121.SH.K.D	-	6251	6	126
e	1	HAPPEN	TAPA 210 CR-FUMÉE 45X88 GLASS TOP 45X88	256.32.EJ.L	210 FUMÉ	-	-	-

City pag 118 - 119

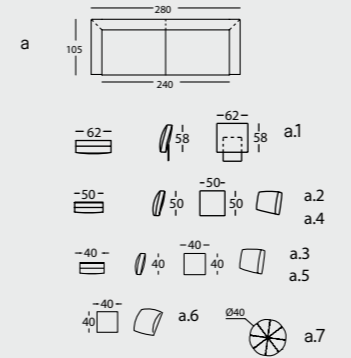

ID	UNI.	MOD.	DESCRIPCIÓN / DESCRIPTION	REF.	ACABADO FINISHES	TELAS / FABRICS ALMOHADA CUSHION BASE	SERIES	MUESTRARIO SAMPLE
a	1	CITY CASUAL	SOFA 280 PATA METAL SOFA 280 METAL FEET	244.11.Z5.6	METAL	2810	3	118
a.1	3	CITY CASUAL	ALMOHADA RESPALDO 62X58 BACK CUSHION 62X58	244.28.GF.M	-	2810	3	118
a.2	1	CITY CASUAL	COJIN DECORACION 50X50 CON BANDA CUSHION 50X50 WITH BAND	243.21.FF	-	2811	3	118
a.3	1	CITY CASUAL	COJIN DECORACION 40X40 CON BANDA CUSHION 40X40 WITH BAND	243.21.EE	-	2811	3	118
a.4	1	CITY CASUAL	COJIN DECORACION 50X50 CON BANDA CUSHION 50X50 WITH BAND	243.21.FF	-	5005	5	122
a.5	1	CITY CASUAL	COJIN DECORACION 40X40 CON BANDA CUSHION 40X40 WITH BAND	243.21.EE	-	5005	5	122
a.6	1	RIFT	COJIN 40X40 TEJA CUSHION 40X40 BRICK-RED	324.22.EE.C2	-	-	-	-
a.7	1	MANDARINA	COJIN D40X14 FRUNCIDO WINKLED CUSHION D40X14	267.24.E.O	-	ATLANTIC 62049	2	112
b	1	CITY SOFT	SOFA 280 PATA METAL SOFA 280 METAL FEET	243.11.Z5.7	-	8069	7	116
b.1	1	MANDARINA	COJIN D40X14 FRUNCIDO WINKLED CUSHION D40X14	267.24.E.O	-	2803	3	118
b.2	1	COJIN CUSHION	COJIN DECORACION 60x60 CUSHION 60x60	-	-	6103	6	114
c	1	CITY CASUAL	SOFA 280 PATA MADERA SOFA 280 WOODEN FEET	244.11.Z5.6	-	5030	5	128
c.1	3	CITY CASUAL	ALMOHADA RESPALDO 62X58 BACK CUSHION 62X58	244.28.GF.M	-	5030	5	128
c.2	3	CITY CASUAL	COJIN DECORACION 50X50 CON BANDA CUSHION 50X50 WITH BAND	243.21.FF	-	5034	5	128
c.3	1	CITY CASUAL	COJIN DECORACION 50X50 CON BANDA CUSHION 50X50 WITH BAND	243.21.FF	-	6251	6	126
c.4	1	MANDARINA	COJIN Ø58X15 CON PELLIZCOS CUSHION Ø58X15 WITH PINCHES	267.24.F.P	-	2852	2	125
c.5	1	COJIN CUSHION	COJIN DECORACION 40X40 CUSHION 40X40	100.22.DD	-	6255	6	126

City pag 120 -121

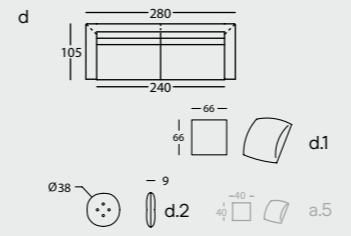

ID	UNI.	MOD.	DESCRIPCIÓN / DESCRIPTION	REF.	ACABADO FINISHES	TELAS / FABRICS ALMOHADA CUSHION BASE	SERIES	MUESTRARIO SAMPLE
d	1	CITY SOFT	SOFA 280 PATA METAL SOFA 280 METAL FEET	243.11.Z5.7	-	2801	3	118
d.1	1	COJIN CUSHION	COJIN DECORACION 60x60 CUSHION 60x60	100.22.GG	-	2810	3	118
d.2	1	PARTY	COJIN D38X9 CUSHION D38X9	277.24.D.W	-	2810 / 2801	3	118



Duo pag 130 - 131

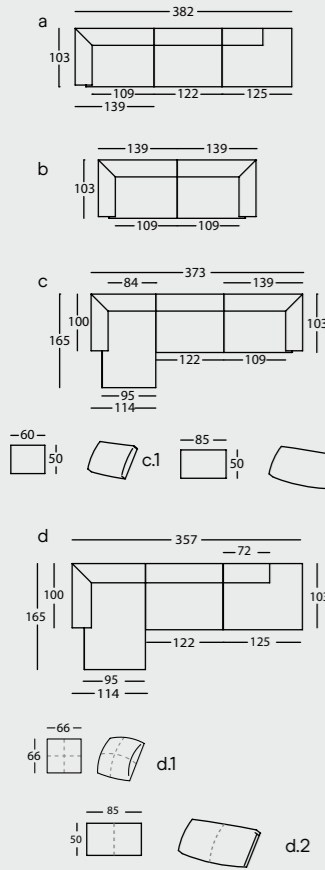

ID	UNI.	MOD.	DESCRIPCIÓN / DESCRIPTION	REF.	ACABADO FINISHES	TELAS / FABRICS	SERIES	MUESTRARIO SAMPLE
						ALMOHADA CUSHION	BASE	
a	1	DUO	MODULO 139 BRAZO IZDO MODULE 139 LEFT ARM	082.122.P.I	-	5032	5	128
a	1	DUO	MODULO 122 MODULE 122	082.121.N	-	5032	5	128
a	1	DUO	MOD. TERMINAL 125 RESPALDO 72 DCHO TERMINAL MODULE125 BACK 72 RIGHT	082.17.NH.D	-	5032	5	128
b	1	DUO	MODULO 139 BRAZO IZDO MODULE 139 LEFT ARM	082.122.P.I	-	5032	5	128
b	1	DUO	MODULO 139 BRAZO DCHO MODULE 139 RIGHT ARM	082.122.P.D	-	5032	5	128
c	1	DUO	CHAISE LONGUE 114 BRAZO IZDO CHAISE LONGUE 114 LEFT ARM	082.142.MS.I	-	5032	5	128
c	1	DUO	MODULO 122 MODULE 122	082.121.N	-	5032	5	128
c	1	DUO	MODULO 139 BRAZO DCHO MODULE 139 RIGHT ARM	082.122.P.D	-	5032	5	128
c.1	2	COJIN CUSHION	ALMOHADA DECORACION 60X50 PUNTAS COSIDAS CUSHION 60X50 STITCHED CORNERS	100.23.GF	-	STEP 63075	3	108
c.2	1	COJIN CUSHION	ALMOHADA DECORACION 85X50 PUNTAS COSIDAS CUSHION 85X50 STITCHED CORNERS	100.23.JF	-	STEP 63075	3	108
d	1	DUO	MOD. TERMINAL 125 RESPALDO 72 DCHO TERMINAL MODULE 125 BACK 72 RIGHT	082.17.NH.D	-	CRYSTAL FIELD 153	10	KVADRAT
d	1	DUO	MODULO 122 MODULE 122	082.121.N	-	CRYSTAL FIELD 153	10	KVADRAT
d	1	DUO	CHAISE LONGUE 114 BRAZO DCHO CHAISE LONGUE 114 RIGHT ARM	082.142.MS.D	-	CRYSTAL FIELD 153	10	KVADRAT
d.1	1	COJIN CUSHION	COJIN DECORACION 66X66 CUSHION 66X66	100.22.GG	-	ATLANTIC 62049	2	112
d.2	2	COJIN CUSHION	ALMOHADA DECORACION 85X50 PUNTAS COSIDAS CUSHION 85X50 STITCHED CORNERS	100.23.JF	-	CRYSTAL FIELD 153	10	KVADRAT

Nosso pag 136 - 137

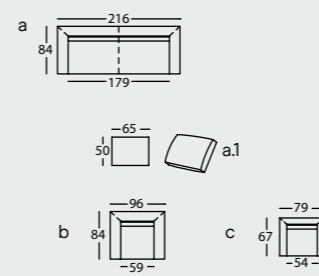

Sofá cama Sofa bed

Nap pag 138 - 139

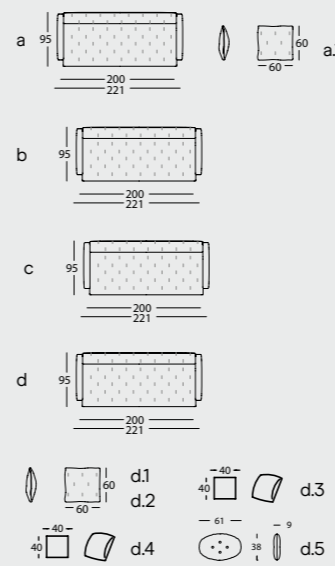

ID	UNI.	MOD.	DESCRIPCIÓN / DESCRIPTION	REF.	ACABADO FINISHES	TELAS / FABRICS	SERIES	MUESTRARIO SAMPLE
						ALMOHADA CUSHION	BASE	
a	1	NOSSO	SOFA 216 SOFA 216	246.11.X	-	7212	7	127
a.1	2	COJIN CUSHION	ALMOHADA 65X50 CON BANDA CUSHION 65X50 WITH BAND	100.21.GK	-	7212	7	127
b	1	NOSSO	SILLON 96 ARMCHAIR 96	246.11.K	-	6253	6	126
c	1	NOSSO	BUTACA SMALL ARMCHAIR	246.51.J	-	2810	3	108

ID	UNI.	MOD.	DESCRIPCIÓN / DESCRIPTION	REF.	ACABADO FINISHES	TELAS / FABRICS	SERIES	MUESTRARIO SAMPLE
						ALMOHADA CUSHION	BASE	
a	1	NAP	BASE SOFA 220 - CAMA 140X200 SOFA 220 - BED 140X200	291.18.Y.B	-	FACET 2 1000	4	107.2
a.1	3	NAP	COJIN DECORACION 60x60 CUSHION 60x60	291.22.GG	-	FACET 2 1000	4	107.2
a.2	1	NAP	COJIN DECORACION 60x60 CUSHION 60x60	291.22.GG	-	7170	5	106
b	1	NAP	BASE SOFA 220 - CAMA 140X200 SOFA 220 - BED 140X200	291.18.Y.B	-	STEELCUT 2 265	8	KVADRAT
c	1	NAP	BASE SOFA 220 - CAMA 140X200 SOFA 220 - BED 140X200	291.18.Y.B	-	1642	4	101
d	1	NAP	BASE SOFA 220 - CAMA 140X200 SOFA 220 - BED 140X200	291.18.Y.B	-	6253	6	126
d.1	3	NAP	COJIN DECORACION 60x60 CUSHION 60x60	291.22.GG	-	6253	6	126
d.2	1	NAP	COJIN DECORACION 60x60 CUSHION 60x60	291.22.GG	-	MEMORY 2 256	8	KVADRAT
d.3	1	RIFT	COJIN FINO 66X66 TEJA FLOPPY CUSHION 66X66 BRIK-RED	324.22.GG.C2X	-	-	-	-
d.4	1	COJIN CUSHION	COJIN DECORACION 40X40 CUSHION 40X40	100.22.DD	-	ATLANTIC 6235	6	123
d.5	1	PARTY	COJIN 61X38X9 CUSHION 61X38X9	277.24.GE.W	-	1631 / 2811	4/3	101 / 118

Moon pag 132 - 133

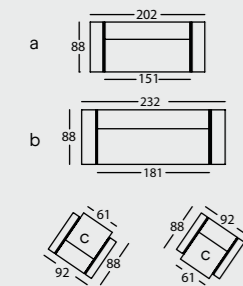

ID	UNI.	MOD.	DESCRIPCIÓN / DESCRIPTION	REF.	ACABADO FINISHES	TELAS / FABRICS	SERIES	MUESTRARIO SAMPLE
						ALMOHADA CUSHION	BASE	
a	1	MOON	SOFA 202 BRAZO ALTO SOFA 202 HIGH ARM	102.11.W.3	123 ULTRAMAR	FACET 2 74	4	107.2
b	1	MOON	SOFA 232 BRAZO BAJO SOFA 232 LOW ARM	102.11.Z.1	003 NOGAL	6253	6	126
c	2	MOON	SILLON 92 BRAZO ESTRECHO ARMCHAIR 92 NARROW ARM	102.11.K.2	002 NATURAL	PLANUM 521	8	FEBRIK KVADRAT

Moon pag 134 - 135

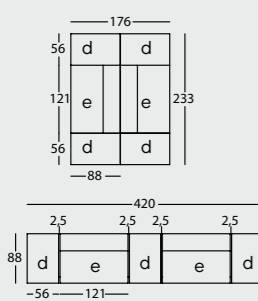

ID	UNI.	MOD.	DESCRIPCIÓN / DESCRIPTION	REF.	ACABADO FINISHES	TELAS / FABRICS	SERIES	MUESTRARIO SAMPLE
						ALMOHADA CUSHION	BASE	
d	4	MOON	PUF 88x56 POUF 88X56	102.151.FJ	002 NATURAL	ATLANTIC 62049	2	112
e	2	MOON	MODULO 121 MODULE 121	102.121.N	002 NATURAL	ATLANTIC 62049	2	112

Tortuga pag 142 - 143

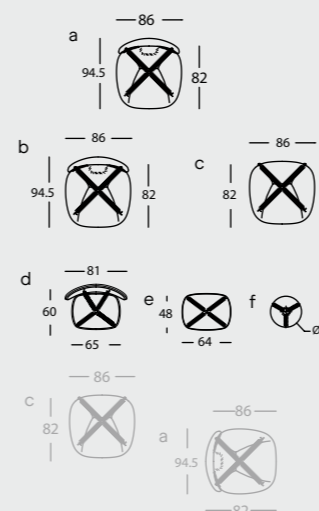

ID	UNI.	MOD.	DESCRIPCIÓN / DESCRIPTION	REF.	ACABADO FINISHES	TELAS / FABRICS	SERIES	MUESTRARIO SAMPLE
						ALMOHADA CUSHION	BASE	
a	1	TORTUGA	BASE SILLON ARMCHAIR BASE	305.65.B	052 KLEIN	UNIFORM M OIL 333	8	FEBRIK KVADRAT
a	1	TORTUGA	CABEZAL SILLON ARMCHAIR HEADREST	305.65.C	-	RAZZLE DAZZLE GINGER 466	9	FEBRIK KVADRAT
b	1	TORTUGA	BASE SILLON ARMCHAIR BASE	305.65.B	041 MALAQUITA	NABUK 27	12	NABUK
b	1	TORTUGA	CABEZAL SILLON ARMCHAIR HEADREST	305.65.C	-	NABUK 27	12	NABUK
c	1	TORTUGA	BUTACA SMALL ARMCHAIR	305.51	003 NOGAL	8069	7	116
d	1	TORTUGA	BASE BUTACA MINI MINI LOUNGE CHAIR BASE	305.56	006 ANTRACITA	GALAXY 948	7	KVADRAT
d	1	TORTUGA	RESPALDO BUTACA MINI MINI LOUNGE CHAIR BACK	305.56.R	-	GALAXY 948	7	KVADRAT
e	1	TORTUGA	PUF 65X50X42 POUF 65X50X42	305.15	041 MALAQUITA	GALAXY 948	7	KVADRAT
f	1	TORTUGA	MESA D41X45 TABLE D41X45	305.71	045 ROSA	-	-	-

Tortuga pag 144 - 145

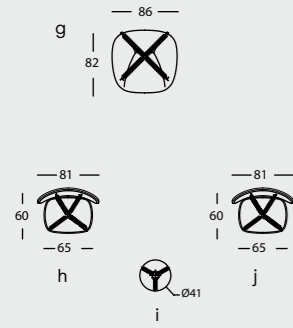

ID	UNI.	MOD.	DESCRIPCIÓN / DESCRIPTION	REF.	ACABADO FINISHES	TELAS / FABRICS		SERIES	MUESTRARIO SAMPLE
						ALMOHADA CUSHION	BASE		
g	1	TORTUGA	BUTACA SMALL ARMCHAIR	305.51	053 TEJA	2811		3	118
h	1	TORTUGA	BASE BUTACA MINI MINI LOUNGE CHAIR BASE	305.56	052 KLEIN	GALAXY 348		7	KVADRAT
h	1	TORTUGA	RESPALDO BUTACA MINI MINI LOUNGE CHAIR BACK	305.56.R	-	GALAXY 348		7	KVADRAT
i	1	TORTUGA	MESA D41X45 TABLE D41X45	305.71	041 MALAQUITA	-		-	-
j	1	TORTUGA	BASE BUTACA MINI MINI LOUNGE CHAIR BASE	305.56	041 MALAQUITA	6236		6	123
j	1	TORTUGA	RESPALDO BUTACA MINI MINI LOUNGE CHAIR BACK	305.56.R	-	6236		6	123

Tortuga pag 146 - 147

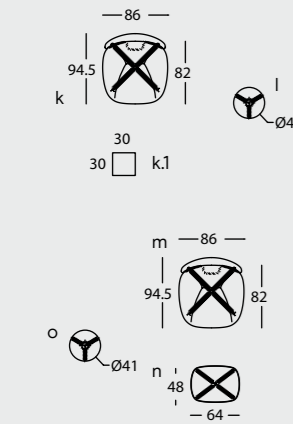

ID	UNI.	MOD.	DESCRIPCIÓN / DESCRIPTION	REF.	ACABADO FINISHES	TELAS / FABRICS		SERIES	MUESTRARIO SAMPLE
						ALMOHADA CUSHION	BASE		
k	1	TORTUGA	BASE SILLON ARMCHAIR BASE	305.65.B	002 NATURAL	817 PERLA		12	CLASSIC 2
k	1	TORTUGA	CABEZAL SILLON ARMCHAIR HEADREST	305.65.C	-	817 PERLA		12	CLASSIC 2
k.1	1	COJIN CUSHION	COJIN DECORACION 30X30 CUSHION 30X30	100.22.CC	-	2811		3	118
l	1	TORTUGA	MESA D41X45 TABLE D41X45	305.71	002 NATURAL	-		-	-
m	1	TORTUGA	BASE SILLON ARMCHAIR BASE	305.65.B	003 NOGAL	810 BAOBAB		12	CLASSIC 2
m	1	TORTUGA	CABEZAL SILLON ARMCHAIR HEADREST	305.65.C	-	810 BAOBAB		12	CLASSIC 2
n	1	TORTUGA	PUF 65X50X42 POUF 65X50X42	305.15	003 NOGAL	6120		6	115
o	1	TORTUGA	MESA D41X45 TABLE D41X45	305.71	043 MANGO	-		-	-

Magnum pag 148 - 149

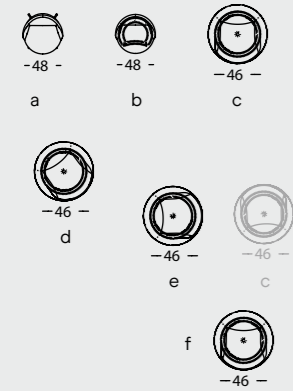

ID	UNI.	MOD.	DESCRIPCIÓN / DESCRIPTION	REF.	ACABADO FINISHES	TELAS / FABRICS		SERIES	MUESTRARIO SAMPLE
						ALMOHADA CUSHION	BASE		
a	1	MAGNUM	TABURETE BAJO PATAS METAL LOW STOOL WITH METAL FEET	311.462.7	088 ORO	GALAXY 608		7	KVADRAT
b	1	MAGNUM	SILLA BASE TAPIZADA CHAIR WITH UPHOLSTERED BASE	311.41	-	FIORD 201		8	KVADRAT
c	1	MAGNUM	BUTACA CON ZÓCALO LOUNGE CHAIR WITH PLINTH	311.55.Z	088 ORO	GALAXY 408		7	KVADRAT
d	1	MAGNUM	BUTACA CON ZÓCALO LOUNGE CHAIR WITH PLINTH	311.55.Z	088 ORO	2810		3	118
e	1	MAGNUM	BUTACA PIE CENTRAL LACADO LOUNGE CHAIR LACQ. CENTRAL LEG	311.55	112 MALAQUITA	6119		6	115
f	1	MAGNUM	BUTACA CON ZÓCALO LOUNGE CHAIR WITH PLINTH	311.55.Z	088 ORO	PLANUM 411		8	FEBRIK KVADRAT

Magnum pag 150 - 151

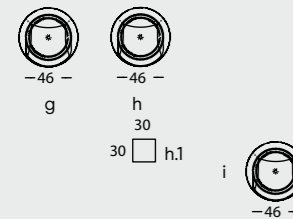

ID	UNI.	MOD.	DESCRIPCIÓN / DESCRIPTION	REF.	ACABADO FINISHES	TELAS / FABRICS		SERIES	MUESTRARIO SAMPLE
						ALMOHADA CUSHION	BASE		
g	1	MAGNUM	BUTACA CON ZÓCALO LOUNGE CHAIR WITH PLINTH	311.55.Z	088 ORO	STEP 65018		3	108
h	1	MAGNUM	BUTACA PIE CENTRAL LACADO LOUNGE CHAIR LACQ. CENTRAL LEG	311.55	123 ULTRAMAR	PLANUM 411		8	FEBRIK KVADRAT
h.1	1	COJIN CUSHION	COJIN DECORACION 30X30 CUSHION 30X30	100.22.CC	-	STEP 65018		3	108
i	1	MAGNUM	BUTACA CON ZÓCALO LOUNGE CHAIR WITH PLINTH	311.55.Z	113 MANGO	FACET 2 1000		4	107.2

Tonella pag 152 - 153

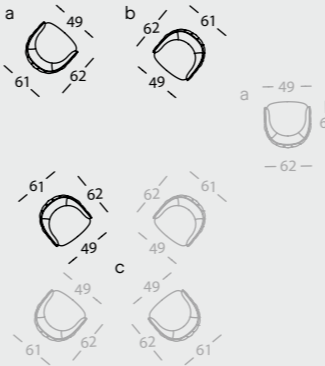

ID	UNI.	MOD.	DESCRIPCIÓN / DESCRIPTION	REF.	ACABADO FINISHES	TELAS / FABRICS		SERIES	MUESTRARIO SAMPLE
						ALMOHADA CUSHION	BASE		
a	1	TONELLA	TONELLA BUTACA ACOLCHADA TONELLA QUILTED MINI ARMCHAIR	301.51.G	103 NACAR	SPRINKLES DUCK 254		8	FEBRIK KVADRAT
b	1	TONELLA	TONELLA BUTACA ACOLCHADA TONELLA QUILTED MINI ARMCHAIR	301.51.G	103 NACAR	SPRINKLES DUCK 254	805 CHESTNUT	9 / 12	FEBRIK KVADRAT / CLASSIC 2
c	4	TONELLA	TONELLA BUTACA ACOLCHADA TONELLA QUILTED MINI ARMCHAIR	301.51.G	103 NACAR	2810	GALAXY 608	3 / 7	118 / KVADRAT

Tonella pag 154 - 155

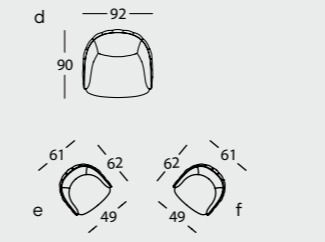

ID	UNI.	MOD.	DESCRIPCIÓN / DESCRIPTION	REF.	ACABADO FINISHES	TELAS / FABRICS		SERIES	MUESTRARIO SAMPLE
						ALMOHADA CUSHION	BASE		
d	1	TONELLA	SILLON 92 ACOLCHADO QUILTED ARMCHAIR 92	301.61.K	103 NACAR	6091		6	103
e	1	TONELLA	TONELLA BUTACA ACOLCHADA TONELLA QUILTED MINI ARMCHAIR	301.51.G	104 BRONCE	STEELCUT TRIO 3 376	FACET 2 1008	8 / 4	KVADRAT / 107.2
f	1	TONELLA	TONELLA BUTACA ACOLCHADA TONELLA QUILTED MINI ARMCHAIR	301.51.G	104 BRONCE	MEMORY 2 256	REMIX 2 653	8 / 6	KVADRAT

Nido pag 156 - 157

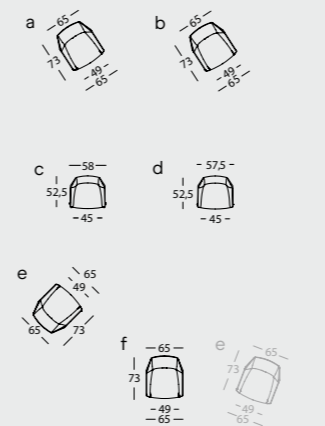

ID	UNI.	MOD.	DESCRIPCIÓN / DESCRIPTION	REF.	ACABADO FINISHES	TELAS / FABRICS		SERIES	MUESTRARIO SAMPLE
						ALMOHADA CUSHION	BASE		
a	1	NIDO	BUTACA PATA MADERA CON VIVO SMALL ARMCHAIR WITH WOODEN FEET & PIPING	288.51	055 SOMBRA	FACET 2 1003	7170	4/5	107.2 / 106
b	1	NIDO	BUTACA PATA METAL CON CREMALLERA SMALL ARMCHAIR WITH METAL FEET & ZIP	288.51.C7	151 NEGRO	STEP 65018		3	108
c	1	NIDO	SILLA PATA MADERA ACOLCHADA C/VIVO QUILTED DINING CH. WOOD FT. & PIPING	288.41.6G	107 BLANCO	7204 RIFT		7	124
d	1	NIDO	SILLA PATA METAL C/VIVO DINING CH. METAL FEET & PIPING	288.41.7	151 NEGRO	GALAXY 108		7	KVADRAT
e	1	NIDO	BUTACA PATA MADERA CON CREMALLERA SMALL ARMCHAIR WITH WOODEN FEET & ZIP	288.51.C	002 NATURAL	REMIX 2 612		6	KVADRAT
f	1	NIDO	BUTACA PATA MADERA CON VIVO SMALL ARMCHAIR WITH WOODEN FEET & PIPING	288.51	002 NATURAL	MEMORY 2 116		8	KVADRAT

Talo pag 158 - 159

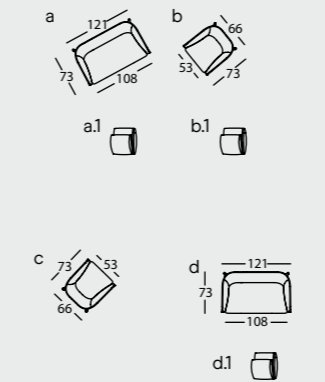

ID	UNI.	MOD.	DESCRIPCIÓN / DESCRIPTION	REF.	ACABADO FINISHES	TELAS / FABRICS		SERIES	MUESTRARIO SAMPLE
						ALMOHADA CUSHION	BASE		
a	1	TALO	SOFA SOFA	290.11	041 MALAQUITA	3875		2	102
a.1	2	TALO	COJIN CUSHION	290.23	-	STEELCUT TRIO 3 953		8	KVADRAT
b	1	TALO	BUTACA SMALL ARMCHAIR	290.51	041 MALAQUITA	REMIX 2 982		6	KVADRAT
b.1	1	TALO	COJIN CUSHION	290.23	-	STEP 68119		3	108
c	1	TALO	BUTACA SMALL ARMCHAIR	290.51	054 CURRY	REMIX 2 433		6	KVADRAT
d	1	TALO	SOFA SOFA	290.11	042 AMARILLO	STEELCUT TRIO 3 453		8	KVADRAT
d.1	2	TALO	COJIN CUSHION	290.23	-	MEMORY 2 236		8	KVADRAT

Talo pag 160 - 161

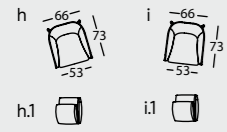

ID	UNI.	MOD.	DESCRIPCIÓN / DESCRIPTION	REF.	ACABADO FINISHES	TELAS / FABRICS		SERIES	MUESTRARIO SAMPLE
						ALMOHADA CUSHION	BASE		
h	1	TALO	BUTACA SMALL ARMCHAIR	290.51	043 MANGO	STEELCUT TRIO	3 746	8	KVADRAT
h.1	1	TALO	COJIN CUSHION	290.23	-	STEP 63012		3	108
i	1	TALO	BUTACA SMALL ARMCHAIR	290.51	043 MANGO	REMIX 2 113		6	KVADRAT
i.1	1	TALO	COJIN CUSHION	290.23	-	STEELCUT TRIO	3 746	8	KVADRAT

Casta pag 162 - 163

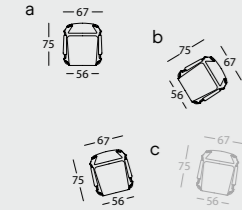

ID	UNI.	MOD.	DESCRIPCIÓN / DESCRIPTION	REF.	ACABADO FINISHES	TELAS / FABRICS		SERIES	MUESTRARIO SAMPLE
						ALMOHADA CUSHION	BASE		
a	1	CASTA	SILLON OMEGA ARMCHAIR OMEGA	287.621.G.0	108 NEGRO	OMEGA 60999		5	GABRIEL
b	1	CASTA	SILLON OMEGA ARMCHAIR OMEGA	287.621.G.0	108 NEGRO	OMEGA 61147		5	GABRIEL
c	2	CASTA	SILLON OMEGA ARMCHAIR OMEGA	287.621.G.0	002 NATURAL	OMEGA 68116		5	GABRIEL

Boomerang pag 164 - 165

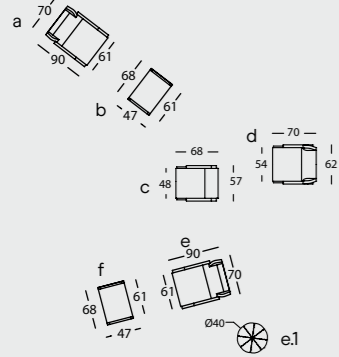

ID	UNI.	MOD.	DESCRIPCIÓN / DESCRIPTION	REF.	ACABADO FINISHES	TELAS / FABRICS		SERIES	MUESTRARIO SAMPLE
						ALMOHADA CUSHION	BASE		
a	1	BOOMERANG CHILL	SILLON OREJERO WING ARMCHAIR	003.631.H	002 NATURAL	6256		6	126
b	1	BOOMERANG CHILL	PUF POUF	003.151.H	002 NATURAL	6256		6	126
c	1	BOOMERANG	BUTACA SMALL ARMCHAIR	003.52.F	002 NATURAL	REMIX 2 643		6	KVADRAT
d	1	BOOMERANG	BUTACA OREJERO WING SMALL ARMCHAIR	003.631.G	002 NATURAL	REMIX 2 842		6	KVADRAT
e	1	BOOMERANG CHILL	SILLON OREJERO WING ARMCHAIR	003.631.H	108 NEGRO	GALAXY 108		7	KVADRAT
e.1	1	MANDARINA	COJIN D40X14 FRUNCIDO WINKLED CUSHION D40X14	267.24.E.0	-	GALAXY 408		7	KVADRAT
f	1	BOOMERANG CHILL	PUF POUF	003.151.H	108 NEGRO	GALAXY 108		7	KVADRAT

Soul pag 166 - 167

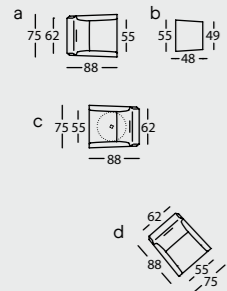

ID	UNI.	MOD.	DESCRIPCIÓN / DESCRIPTION	REF.	ACABADO FINISHES	TELAS / FABRICS		SERIES	MUESTRARIO SAMPLE
						ALMOHADA CUSHION	BASE		
a	1	SOUL	SILLÓN PATA MADERA ZOCALO TAPIZADO ARMCHAIR WOODEN FEET UPHOL. BASE	273.61.T	002 NATURAL	STEELCUT 2 120		8	KVADRAT
b	1	SOUL	PUF ZOCALO TAPIZADO POUF UPHOLSTERED BASE	273.151.T	-	STEELCUT 2 120		8	KVADRAT
c	1	SOUL	SILLÓN PIE GIRATORIO ZOCALO MADERA ARMCHAIR REVOLVING PEDESTAL WOODEN BASE	273.65.Z	002 NATURAL/ 001 NEGRO	STEP MELANGE 60011		3	108
d	1	SOUL	SILLÓN PATA MADERA ZOCALO TAPIZADO ARMCHAIR WOODEN FEET UPHOL. BASE	273.61.T	003 NOGAL	STEELCUT 2 435		8	KVADRAT

Hera pag 168

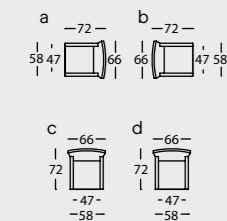

ID	UNI.	MOD.	DESCRIPCIÓN / DESCRIPTION	REF.	ACABADO FINISHES	TELAS / FABRICS		SERIES	MUESTRARIO SAMPLE
						ALMOHADA CUSHION	BASE		
a	1	HERA	BUTACA SMALL ARMCHAIR	006.51	-	FACET 2 1000		4	107.2
b	1	HERA	BUTACA SMALL ARMCHAIR	006.51	-	FACET 2 72		4	107.2
c	1	HERA	BUTACA SMALL ARMCHAIR	006.51	-	FACET 2 1007		4	107.2
d	1	HERA	BUTACA SMALL ARMCHAIR	006.51	-	STEP 67004		3	108

Nómada pag 169

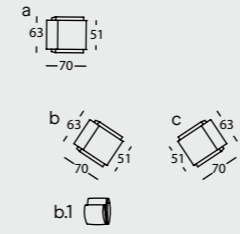

ID	UNI.	MOD.	DESCRIPCIÓN / DESCRIPTION	REF.	ACABADO FINISHES	TELAS / FABRICS		SERIES	MUESTRARIO SAMPLE
						ALMOHADA CUSHION	BASE		
a	1	NOMADA	BUTACA BRAZOS MADERA SMALL ARMCHAIR WOODEN ARM	099.521	006 ANTRACITA	STEP MELANGE 60021		3	108
b	1	NOMADA	BUTACA BRAZOS MADERA SMALL ARMCHAIR WOODEN ARM	099.521	002 NATURAL	STEP 65018		3	108
b.1	1	TALO	COJIN CUSHION	290.23	-	STEP 65018		3	108
c	1	NOMADA	BUTACA BRAZOS MADERA SMALL ARMCHAIR WOODEN ARM	099.521	002 NATURAL	MEMORY 2 156		8	KVADRAT

Moss pag 170

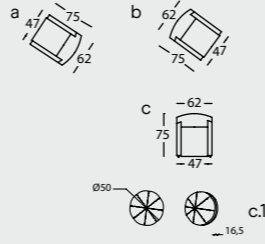

ID	UNI.	MOD.	DESCRIPCIÓN / DESCRIPTION	REF.	ACABADO FINISHES	TELAS / FABRICS		SERIES	MUESTRARIO SAMPLE
						ALMOHADA CUSHION	BASE		
a	1	MOSS	BUTACA SMALL ARMCHAIR	227.52	-	GRAPHITE 954		4	CADET
b	1	MOSS	BUTACA SMALL ARMCHAIR	227.52	-	1636		4	101
c	1	MOSS	BUTACA SMALL ARMCHAIR	227.52	-	STEP MELANGE 68118		3	108
c.1	1	MANDARINA	COJIN D50X16,5 FRUNCIDO WINKLED CUSHION D50X16,5	267.24.E.0	-	STEP 63012		3	108

Club pag 171

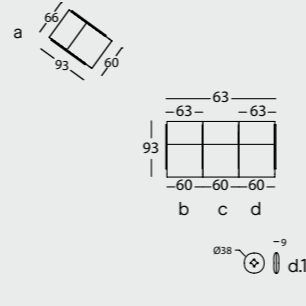

ID	UNI.	MOD.	DESCRIPCIÓN / DESCRIPTION	REF.	ACABADO FINISHES	TELAS / FABRICS		SERIES	MUESTRARIO SAMPLE
						ALMOHADA CUSHION	BASE		
a	1	CLUB	BUTACA BRAZOS METAL SMALL ARMCHAIR METAL ARM	104.523.H	084 CROMADO	910187		10	L-5
b	1	CLUB	MOD 63 CON BRAZO METAL IZDO MODULE 63 METAL LEFT ARM	104.122.G.7.I	084 CROMADO	OMEGA 63065		5	GABRIEL
c	1	CLUB	MOD 60 MODULE 60	104.121.G	-	OMEGA 64080		5	GABRIEL
d	1	CLUB	MOD 63 CON BRAZO METAL DCHO MODULE 63 METAL RIGHT ARM	104.122.G.7.D	084 CROMADO	OMEGA 64080		5	GABRIEL
d.1	1	PARTY	COJIN D38X9 CUSHION D38X9	277.24.D.W	-	2810 5005		3 / 5	118/122

Silencio pag 172 - 173

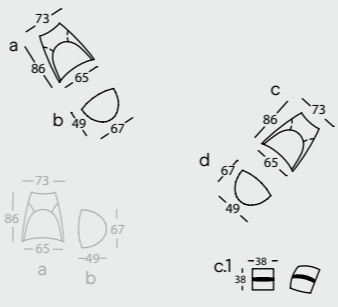

ID	UNI.	MOD.	DESCRIPCIÓN / DESCRIPTION	REF.	ACABADO FINISHES	TELAS / FABRICS		SERIES	MUESTRARIO SAMPLE
						ALMOHADA CUSHION	BASE		
a	1	SILENCIO	BUTACA SMALL ARMCHAIR	031.51	002 NATURAL	FACET 2 012B		4	107.2
b	1	SILENCIO	PUF POUF	031.151	002 NATURAL	FACET 2 012B		4	107.2
c	1	SILENCIO	BUTACA SMALL ARMCHAIR	031.51	108 NEGRO	STEELCUT TRIO 3 124		8	KVADRAT
c.1	1	REW	COJIN 38X38 CUSHION 38X38	292.22.DD	-	MEMORY 2 236		8	KVADRAT
b	1	SILENCIO	PUF POUF	031.151	108 NEGRO	STEELCUT TRIO 3 124		8	KVADRAT

Sillas Dining chairs

Mullit pag 176 - 177

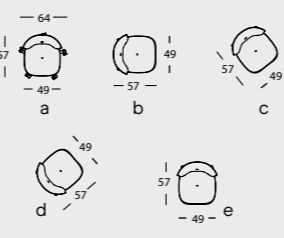

ID	UNI.	MOD.	DESCRIPCIÓN / DESCRIPTION	REF.	ACABADO FINISHES	TELAS / FABRICS		SERIES	MUESTRARIO SAMPLE
						ALMOHADA CUSHION	BASE		
a	1	MULLIT	SILLA CON RUEDAS CHAIR WITH WHEELS	320.40	113 MANGO	7203 RIFT		7	124
b	1	MULLIT	SILLA PATA METAL CHAIR WITH METAL FEET	320.41.7	151 NEGRO	7203 RIFT		7	124
c	1	MULLIT	SILLA ESTRUCTURA METAL METAL STRUCTURE CHAIR	320.41	088 ORO	GALAXY 108		7	KVADRAT
d	1	MULLIT	SILLA ESTRUCTURA METAL METAL STRUCTURE CHAIR	320.41	088 ORO	7201 RIFT		7	124
e	1	MULLIT	SILLA PATA MADERA CHAIR WITH WOODEN FEET	320.41.6	004 CENIZA	6233		6	123

Mullit pag 178 - 179

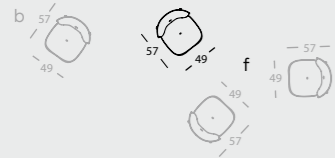

ID	UNI.	MOD.	DESCRIPCIÓN / DESCRIPTION	REF.	ACABADO FINISHES	TELAS / FABRICS ALMOHADA CUSHION	BASE	SERIES	MUESTRARIO SAMPLE
f	3	MULLIT	SILLA ESTRUCTURA METAL METAL STRUCTURE CHAIR	320.41	088 ORO	6153		6	117

Magnum pag 180 - 181

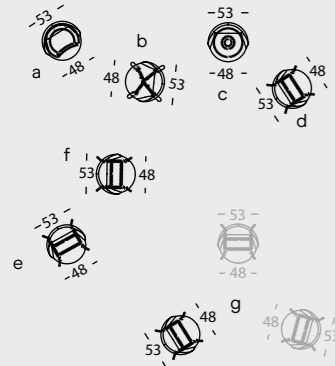

ID	UNI.	MOD.	DESCRIPCIÓN / DESCRIPTION	REF.	ACABADO FINISHES	TELAS / FABRICS ALMOHADA CUSHION	BASE	SERIES	MUESTRARIO SAMPLE
a	1	MAGNUM	SILLA BASE TAPIZADA CHAIR WITH UPHOLSTERED BASE	311.41	-	FIORD 201		8	KVADRAT
b	1	MAGNUM	SILLA PATAS MADERA CHAIR WITH WOODEN FEET	311.41.6	043 MANGO	STEELCUT TRIO 3 553		8	KVADRAT
c	1	MAGNUM	SILLA PIE CENTRAL LACADO CHAIR LACQ. CENTRAL LEG	311.47	124 CHAMPAGNE	PLANUM 411		8	FEBRIK KVADRAT
d	1	MAGNUM	SILLA PATAS METAL CHAIR WITH METAL FEET	311.41.7	088 ORO	STEP 63075		3	108
e	1	MAGNUM	SILLA PATAS METAL CHAIR WITH METAL FEET	311.41.7	001 NEGRO	8072		7	116
f	1	MAGNUM	TABURETE PATAS METAL STOOL WITH METAL FEET	311.464	001 NEGRO	FACET 2 01		4	107.2
g	3	MAGNUM	SILLA PATAS METAL CHAIR WITH METAL FEET	311.41.7	001 NEGRO	STEP MELANGE 68121		3	108

Magnum pag 182 - 183

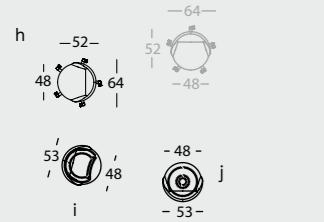

ID	UNI.	MOD.	DESCRIPCIÓN / DESCRIPTION	REF.	ACABADO FINISHES	TELAS / FABRICS ALMOHADA CUSHION	BASE	SERIES	MUESTRARIO SAMPLE
h	2	MAGNUM	SILLA CON RUEDAS CHAIR WITH WHEELS	311.40	093 GRIS CUARZO	GALAXY 408		7	KVADRAT
i	1	MAGNUM	SILLA BASE TAPIZADA CHAIR WITH UPHOLSTERED BASE	311.41	-	5002		5	122
j	1	MAGNUM	SILLA PIE CENTRAL LACADO CHAIR LACQ. CENTRAL LEG	311.47	095 GRIS SEDA	FACET 2 1000		4	107.2

Magnum pag 184 - 185

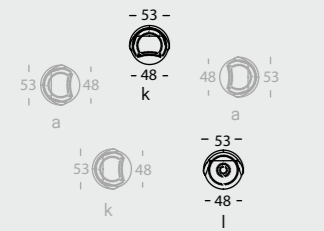

ID	UNI.	MOD.	DESCRIPCIÓN / DESCRIPTION	REF.	ACABADO FINISHES	TELAS / FABRICS ALMOHADA CUSHION	BASE	SERIES	MUESTRARIO SAMPLE
k	1	MAGNUM	SILLA BASE TAPIZADA CHAIR WITH UPHOLSTERED BASE	311.41	-	STEP 63075		3	108
l	1	MAGNUM	SILLA PIE CENTRAL LACADO CHAIR LACQ. CENTRAL LEG	311.47	096 CREMA	GALAXY 608		7	KVADRAT

Nido pag 186 - 187

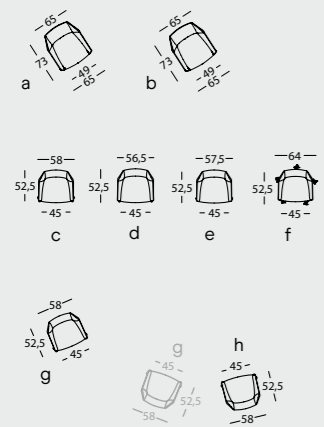

ID	UNI.	MOD.	DESCRIPCIÓN / DESCRIPTION	REF.	ACABADO FINISHES	TELAS / FABRICS ALMOHADA CUSHION	BASE	SERIES	MUESTRARIO SAMPLE
a	1	NIDO	BUTACA PATA MADERA CON VIVO SMALL ARMCHAIR WITH WOODEN FEET & PIPING	288.51	055 SOMBRA	FACET 2 1003	7170	4 / 5	107.2 / 106
b	1	NIDO	BUTACA PATA METAL CON CREAMALLERA SMALL ARMCHAIR WITH METAL FEET & ZIP	288.51.C7	151 NEGRO	STEP 65018		3	108
c	1	NIDO	SILLA PATA MADERA ACOLCHADA C/VIVO QUILTED DINING CH. WOOD FT. & PIPING	288.41.6G	107 BLANCO	7204 RIFT		7	124
d	1	NIDO	SILLA PATA MADERA BASIC C/VIVO DINING CH. BASIC WOOD FEET & PIPING	288.41.61	052 KLEIN	7202 RIFT		7	124
e	1	NIDO	SILLA PATA METAL C/VIVO DINING CH. METAL FEET & PIPING	288.41.7	151 NEGRO	GALAXY 108		7	KVADRAT
f	1	NIDO	SILLA CON RUEDAS C/VIVO ACOLCHADA DINING CH. WITH WHEELS & QUILTED PIPING	288.41.8G	001 NEGRO	STEP 60999		3	108
g	1	NIDO	SILLA PATA MADERA ACOLCHADA C/VIVO QUILTED DINING CH. WOOD FT. & PIPING	288.41.6G	006 ATRANCITA	FACET 2 1003		4	107.2
h	1	NIDO	SILLA PATA MADERA ACOLCHADA C/VIVO QUILTED DINING CH. WOOD FT. & PIPING	288.41.6G	006 ATRANCITA	6233		6	123

Collar pag 188 - 189

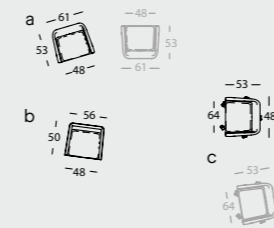

ID	UNI.	MOD.	DESCRIPCIÓN / DESCRIPTION	REF.	ACABADO FINISHES	TELAS / FABRICS ALMOHADA CUSHION	BASE	SERIES	MUESTRARIO SAMPLE
a	2	COLLAR	BASE SILLA PATA METAL CHAIR BASE METAL FEET	296.42.C	151 NEGRO	7170		5	106
a	2	COLLAR	ALMOHADA ASIENTO SEAT CUSHION	296.1B.C	-	STEP 60999		3	108
b	1	COLLAR MAO	BASE SILLA PATA MADERA CHAIR BASE WOODEN FEET	296.41.M	054 CURRY	7174		5	106
b	1	COLLAR MAO	ALMOHADA ASIENTO SEAT CUSHION	296.1B.M	-	STEELCUT 2 985		8	KVADRAT
c	2	COLLAR	BASE SILLA CON RUEDAS CHAIR BASE WITH WHEELS	296.43.C	112 MALAQUITA	GALAXY 408		7	KVADRAT
c	2	COLLAR	ALMOHADA ASIENTO SEAT CUSHION	296.1B.C	-	GALAXY 408		7	KVADRAT

Collar pag 190 - 191

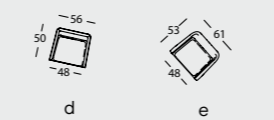

ID	UNI.	MOD.	DESCRIPCIÓN / DESCRIPTION	REF.	ACABADO FINISHES	TELAS / FABRICS ALMOHADA CUSHION	BASE	SERIES	MUESTRARIO SAMPLE
d	1	COLLAR MAO	BASE SILLA PATA METAL CHAIR BASE METAL FEET	296.42.M	151 NEGRO	6115		6	115
d	1	COLLAR MAO	ALMOHADA ASIENTO SEAT CUSHION	296.1B.M	-	GALAXY 408		7	KVADRAT
e	1	COLLAR	BASE SILLA PATA MADERA CHAIR BASE WOODEN FEET	296.41.C	049 GRIS SEDA	ATLANTIC 66126		2	112
e	1	COLLAR	ALMOHADA ASIENTO SEAT CUSHION	296.1B.C	-	ATLANTIC 60011		2	112

Silla 40 pag 192 - 193

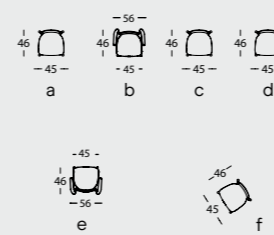

ID	UNI.	MOD.	DESCRIPCIÓN / DESCRIPTION	REF.	ACABADO FINISHES	TELAS / FABRICS ALMOHADA CUSHION	BASE	SERIES	MUESTRARIO SAMPLE
a	1	SILLA 40	SILLA R40 '40s CHAIR	295.41.3	002 NATURAL	ATLANTIC 60011		2	112
b	1	SILLA 40	R70 METAL CON BRAZOS '70s METAL CHAIR WITH ARMS	295.42.M.4	005 BLANCO / 002 NATURAL	STEP 60004		3	108
c	1	SILLA 40	R30 METAL '30s METAL CHAIR	295.41.M.2	005 BLANCO	MEMORY 2 123		8	KVADRAT
d	1	SILLA 40	SILLA R20 '20s CHAIR	295.41.1	042 AMARILLO	MEMORY 2 453		8	KVADRAT
e	1	SILLA 40	R30 METAL CON BRAZOS '30s METAL CHAIR WITH ARMS	295.42.M.2	001 NEGRO / 002 NATURAL	6115		6	115
f	1	SILLA 40	SILLA R20 '20s CHAIR	295.41.1	108 NEGRO	MEMORY 2 976		8	KVADRAT

Silla 40 pag 194 195

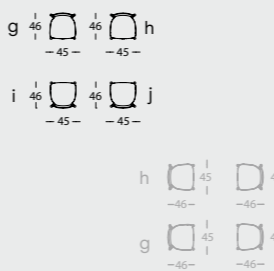

ID	UNI.	MOD.	DESCRIPCIÓN / DESCRIPTION	REF.	ACABADO FINISHES	TELAS / FABRICS ALMOHADA CUSHION	BASE	SERIES	MUESTRARIO SAMPLE
g	1	SILLA 40	SILLA R70 '70s CHAIR	295.41.4	052 KLEIN	REMIX 2 123		6	KVADRAT
h	1	SILLA 40	SILLA R40 '40s CHAIR	295.41.3	052 KLEIN	REMIX 2 233		6	KVADRAT
i	1	SILLA 40	SILLA R30 '30s CHAIR	295.41.2	052 KLEIN	REMIX 2 143		6	KVADRAT
j	1	SILLA 40	SILLA R20 '20s CHAIR	295.41.1	052 KLEIN	REMIX 2 242		6	KVADRAT

Ártica pag 196 - 197

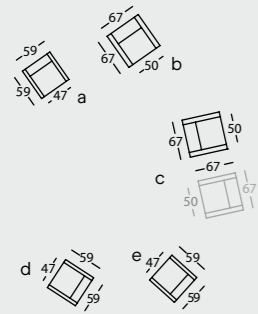

ID	UNI.	MOD.	DESCRIPCIÓN / DESCRIPTION	REF.	ACABADO FINISHES	TELAS / FABRICS		SERIES	MUESTRARIO SAMPLE
						ALMOHADA CUSHION	BASE		
a	1	ARTICA	SILLA CON BRAZOS CHAIR WITH ARMS	164.22	082 PULIDO	STEP 62057	3	108	
b	1	ARTICA	BUTACA SMALL ARMCHAIR	164.51	082 PULIDO	STEP 62057	3	108	
c	2	ARTICA	BUTACA SMALL ARMCHAIR	164.51	082 PULIDO	ATLANTIC 66086	2	112	
d	1	ARTICA	SILLA CON BRAZOS CHAIR WITH ARMS	164.22	005 BLANCO	STEELCUT TRIO 3 983	8	KVADRAT	
e	1	ARTICA	SILLA CON BRAZOS CHAIR WITH ARMS	164.22	005 BLANCO	STEELCUT 2 820	8	KVADRAT	

Tea pag 198 - 199

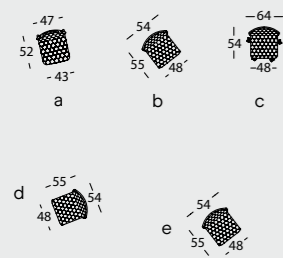

ID	UNI.	MOD.	DESCRIPCIÓN / DESCRIPTION	REF.	ACABADO FINISHES	TELAS / FABRICS		SERIES	MUESTRARIO SAMPLE
						ALMOHADA CUSHION	BASE		
a	1	TEA	TABURETE ACOLCHADO ROBLE QUILTED STOOL WITH OAK FEET	250.46.G	049 GRIS SEDA	FACT2 1000	4	107.2	
b	1	TEA	SILLA ACOLCHADA QUILTED CHAIR	250.41.G	002 NATURAL	2664 STEELCUT TRIO 3 506	3 / 8	72 / KVADRAT	
c	1	TEA	SILLA ACOLCHADA CON RUEDAS QUILTED CHAIR WITH WHEELS	250.40.G	095 GRIS SEDA	6251	6	126	
d	1	TEA	SILLA ACOLCHADA QUILTED CHAIR	250.41.G	002 NATURAL	STEELCUT 2 550	8	KVADRAT	
e	1	TEA	SILLA ACOLCHADA QUILTED CHAIR	250.41.G	049 GRIS SEDA	6102	6	114	

Midori pag 200 - 201

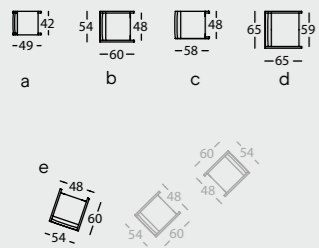

ID	UNI.	MOD.	DESCRIPCIÓN / DESCRIPTION	REF.	ACABADO FINISHES	TELAS / FABRICS		SERIES	MUESTRARIO SAMPLE
						ALMOHADA CUSHION	BASE		
a	1	MIDORI	TABURETE BAJO LOW STOOL	232.462	042 AMARILLO	STEELCUT 2 435	8	KVADRAT	
b	1	MIDORI	SILLA BRAZOS MADERA CHAIR WITH WOODEN ARM	232.421	002 NATURAL	2765	3	104	
c	1	MIDORI	SILLA SIN BRAZOS CHAIR	232.41	003 NOGAL	STEELCUT 2 435	8	KVADRAT	
d	1	MIDORI	BUTACA BRAZOS MADERA SMALL ARMCHAIR WOODEN ARM	232.521	107 BLANCO	910181	10	L-5	
e	3	MIDORI	SILLA BRAZOS MADERA CHAIR WITH WOODEN ARM	232.421	002 NATURAL	STEP MELANGE 61103	3	108	

Bancos Benches

Interchange pag 204 - 205

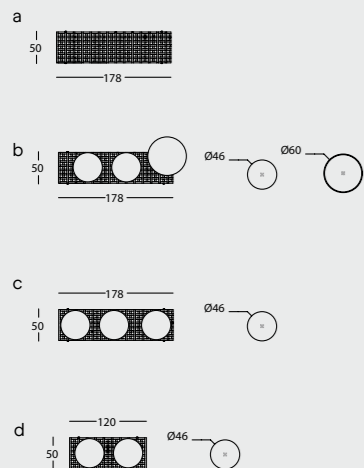

ID	UNI.	MOD.	DESCRIPCIÓN / DESCRIPTION	REF.	ACABADO FINISHES	TELAS / FABRICS		SERIES	MUESTRARIO SAMPLE
						ALMOHADA CUSHION	BASE		
a	1	INTERCHANGE	BANCO 178X50 BENCH 178x50	332.88.T	108 NEGRO	-	-	-	
b	1	INTERCHANGE	BANCO 178X50 BENCH 178x50	332.88.T	055 SOMBRA	-	-	-	
b	1	INTERCHANGE	ASIENTO D46 PACK 2 SEAT D46 PACK 2	332.3R.ED	-	6222	6	121	
b	1	INTERCHANGE	MESITA FRESNO D60 ASH WOOD TABLE D60	332.32.G	002 NATURAL	-	-	-	
c	1	INTERCHANGE	BANCO 178X50 BENCH 178x50	332.88.T	002 NATURAL	-	-	-	
c	1	INTERCHANGE	ASIENTO D46 PACK 2 SEAT D46 PACK 2	332.3R.ED	-	HALLINGDALL 65 600	10	KVADRAT	
c	1	INTERCHANGE	ASIENTO D46 SEAT D46	332.3R.E	-	HALLINGDALL 65 596	10	KVADRAT	
d	1	INTERCHANGE	BANCO 120X50 BENCH 120x50	332.88.N	003 NOGAL	-	-	-	
d	1	INTERCHANGE	ASIENTO D46 PACK 2 SEAT D46 PACK 2	332.3R.ED	-	5005	5	122	

Interchange pag 206 - 207

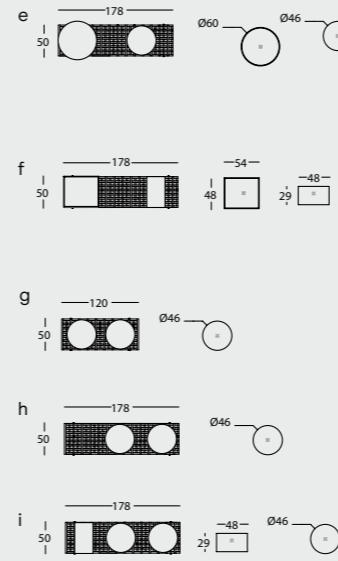

ID	UNI.	MOD.	DESCRIPCIÓN / DESCRIPTION	REF.	ACABADO FINISHES	TELAS / FABRICS		SERIES	MUESTRARIO SAMPLE
						ALMOHADA CUSHION	BASE		
e	1	INTERCHANGE	BANCO 178X50 BENCH 178x50	332.88.T	108 NEGRO	-	-	-	
e	1	INTERCHANGE	MESITA FRESNO D60 ASH WOOD TABLE D60	332.32.G	043 MANGO	-	-	-	
e	1	INTERCHANGE	ASIENTO D46 SEAT D46	332.3R.E	-	HALLINGDALL 65 596	10	KVADRAT	
f	1	INTERCHANGE	BANCO 178X50 BENCH 178x50	332.88.T	003 NOGAL	-	-	-	
f	1	INTERCHANGE	MESITA FRESNO 54X48 ASH WOOD TABLE 54X48	332.32.F	055 SOMBRA	-	-	-	
f	1	INTERCHANGE	MESITA DM BRILLO 29X48 GLOSSY MDF TABLE 29X48	332.3Q.C	129 OXIDO	-	-	-	
g	1	INTERCHANGE	BANCO 120X50 BENCH 120x50	332.88.N	002 NATURAL	-	-	-	
g	1	INTERCHANGE	ASIENTO D46 PACK 2 SEAT D46 PACK 2	332.3R.ED	-	HALLINGDALL 65 600	10	KVADRAT	
h	1	INTERCHANGE	BANCO 178X50 BENCH 178x50	332.88.T	002 NATURAL	-	-	-	
h	1	INTERCHANGE	ASIENTO D46 PACK 2 SEAT D46 PACK 2	332.3R.ED	-	5005	5	122	
i	1	INTERCHANGE	BANCO 178X50 BENCH 178x50	332.88.T	002 NATURAL	-	-	-	
i	1	INTERCHANGE	MESITA DM BRILLO 29X48 GLOSSY MDF TABLE 29X48	332.3Q.C	116 MOSTAZA	-	-	-	
i	1	INTERCHANGE	ASIENTO D46 PACK 2 SEAT D46 PACK 2	332.3R.ED	-	SOFT 44026	12	ELMO SOFT	

La Isla pag 208 - 210

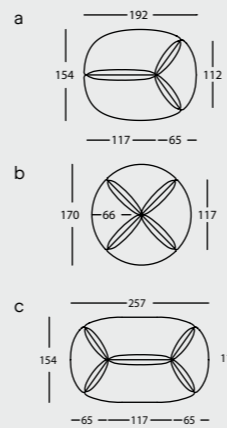

ID	UNI.	MOD.	DESCRIPCIÓN / DESCRIPTION	REF.	ACABADO FINISHES	TELAS / FABRICS		SERIES	MUESTRARIO SAMPLE
						ALMOHADA CUSHION	BASE		
a	1	LA ISLA	BANCO 192X154 BENCH 192X154	314.10.VRH	113 MANGO	UNIFORM MELANGE CORAL 623	8	FEBRIK KVADRAT	
b	1	LA ISLA	BANCO D170 BENCH D170	314.10.TTH	123 ULTRAMAR	ATLANTIC 66126	2	112	
c	1	LA ISLA	BANCO 257X154 BENCH 257X154	314.10.Z2RH	112 MALAQUITA	UNIFORM MELANGE PEACOCK 983	8	FEBRIK KVADRAT	

La Isla pag 211

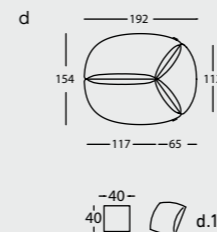

ID	UNI.	MOD.	DESCRIPCIÓN / DESCRIPTION	REF.	ACABADO FINISHES	TELAS / FABRICS		SERIES	MUESTRARIO SAMPLE
						ALMOHADA CUSHION	BASE		
d	1	LA ISLA	BANCO 192X154 BENCH 192X154	314.10.VRH	113 MANGO	GALAXY 608	7	KVADRAT	
d.1	1	C1 - C4	COJIN 40X40 - C1 PIEL CUSHION 40X40 - C1 LEATHER	310.22.C1P	-	-	-	-	

La Isla pag 212 - 213

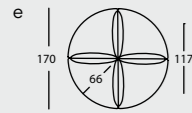

Mosaico pag 214 - 215

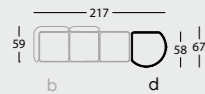
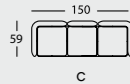
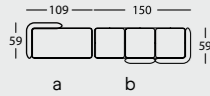

Mosaico pag 216-217

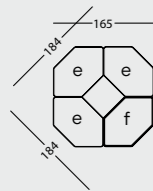

ID	UNI.	MOD.	DESCRIPCIÓN / DESCRIPTION	REF.	ACABADO FINISHES	TELAS / FABRICS	SERIES	MUESTRARIO SAMPLE	
						ALMOHADA CUSHION	BASE		
e	1	LA ISLA	BANCO D170 BENCH D170	314.10.TTH	045 ROSA	2098 ROSÉ	3	SILVERTEX	

ID	UNI.	MOD.	DESCRIPCIÓN / DESCRIPTION	REF.	ACABADO FINISHES	TELAS / FABRICS	SERIES	MUESTRARIO SAMPLE	
						ALMOHADA CUSHION	BASE		
a	1	MOSAICO	BASE 100X50 PARA 1 ALMOHADA BASE 100X50 FOR 1 SEAT	302.89.L.V	053 TEJA	-	-	-	
a	1	MOSAICO	ALMOHADA 100X50 SEAT 100X50	302.15.L.V	-	STEELCUT 2 655	8	KVADRAT	
a	1	MOSAICO	RESPALDO ANGULO CORNER BACK	302.1A.G	-	STEELCUT 2 655	8	KVADRAT	
b	1	MOSAICO	BASE 150X50 BASE 150X50	302.89.R	053 TEJA	-	-	-	
b	3	MOSAICO	ALMOHADA 50X50 SEAT 50X50	302.15.F	-	SPRINKLES PARROT 784	9	FEBRIK KVADRAT	
b	1	MOSAICO	RESPALDO ANGULO CORNER BACK	302.1A.G	-	SPRINKLES PARROT 784	9	FEBRIK KVADRAT	
b	1	MOSAICO	RESPALDO RECTO 50 BACK 50	302.1A.F	-	SPRINKLES PARROT 784	9	FEBRIK KVADRAT	
a-b	1	MOSAICO	PLETINA UNION CONNECTOR	302.31	-	-	-	-	
c	1	MOSAICO	BASE 150X50 BASE 150X50	302.89.R	053 TEJA	-	-	-	
c	3	MOSAICO	ALMOHADA 50X50 SEAT 50X50	302.15.F	-	SPRINKLES PARROT 784	9	FEBRIK KVADRAT	
c	2	MOSAICO	RESPALDO ANGULO CORNER BACK	302.1A.G	-	SPRINKLES PARROT 784	9	FEBRIK KVADRAT	
c	1	MOSAICO	RESPALDO RECTO 50 BACK 50	302.1A.F	-	SPRINKLES PARROT 784	9	FEBRIK KVADRAT	
d	1	MOSAICO	BASE ANGULO CURVO CURVED CORNER BASE	302.89.G	053 TEJA	-	-	-	
d	1	MOSAICO	TAPA ANGULO CURVO CURVED CORNER TOP	302.71.G	401 MARMOL	-	-	-	
b-d	1	MOSAICO	PLETINA UNION CONNECTOR	302.31	-	-	-	-	

ID	UNI.	MOD.	DESCRIPCIÓN / DESCRIPTION	REF.	ACABADO FINISHES	TELAS / FABRICS	SERIES	MUESTRARIO SAMPLE	
						ALMOHADA CUSHION	BASE		
e	3	MOSAICO	BASE HEXAGONAL HEXAGONAL BASE	302.89.M	049 GRIS SEDA	-	-	-	
e	3	MOSAICO	ALMOHADA HEXAGONAL HEXAGONAL SEAT	302.15.M	-	SPRINKLES FINCH 124	9	FEBRIK KVADRAT	
f	1	MOSAICO	BASE HEXAGONAL HEXAGONAL BASE	302.89.M	049 GRIS SEDA	-	-	-	
f	1	MOSAICO	TAPA HEXAGONAL HEXAGONAL TOP	302.71.M	401 MARMOL	-	-	-	
e-e-e-f	4	MOSAICO	PLETINA UNION CONNECTOR	302.31	-	-	-	-	

Mosaico pag 216 - 217

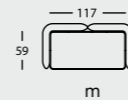
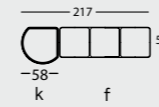
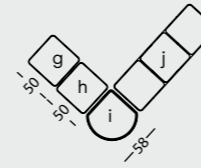

REW pag 218 - 219

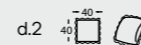
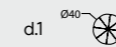
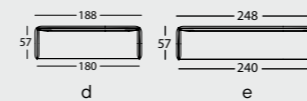
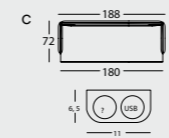
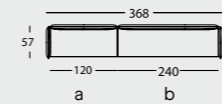

ID	UNI.	MOD.	DESCRIPCIÓN / DESCRIPTION	REF.	ACABADO FINISHES	TELAS / FABRICS	SERIES	MUESTRARIO SAMPLE	
						ALMOHADA CUSHION	BASE		
g	1	MOSAICO	BASE 50X50 BASE 50X50	302.89.F	042 AMARILLO	-	-	-	
g	1	MOSAICO	ALMOHADA 50X50 SEAT 50X50	302.15.F	-	6100	6	114	
h	1	MOSAICO	BASE 50X50 BASE 50X50	302.89.F	042 AMARILLO	-	-	-	
h	1	MOSAICO	TAPA 50X50 TOP 50X50	302.71.F	401 CARRARA	-	-	-	
i	1	MOSAICO	BASE ANGULO CURVO CURVED CORNER BASE	302.89.G	042 AMARILLO	-	-	-	
i	1	MOSAICO	TAPA ANGULO CURVO CURVED CORNER TOP	302.71.G	401 CARRARA	-	-	-	
j	1	MOSAICO	BASE 150X50 BASE 150X50	302.89.R	042 AMARILLO	-	-	-	
j	2	MOSAICO	TAPA 50X50 TOP 50X50	302.71.F	401 CARRARA	-	-	-	
j	1	MOSAICO	ALMOHADA 50X50 SEAT 50X50	302.15.F	-	MEMORY 2 976	8	KVADRAT	
g-h-i-j	3	MOSAICO	PLETINA UNION CONNECTOR	302.31	-	-	-	-	
k	1	MOSAICO	BASE ANGULO CURVO CURVED CORNER BASE	302.89.G	041 MALAQUITA	-	-	-	
k	1	MOSAICO	TAPA ANGULO CURVO CURVED CORNER TOP	302.71.G	401 CARRARA	-	-	-	
l	1	MOSAICO	BASE 150X50 BASE 150X50	302.89.R	041 MALAQUITA	-	-	-	
l	3	MOSAICO	ALMOHADA 50X50 SEAT 50X50	302.15.F	-	SPRINKLES PARROT 784	9	FEBRIK KVADRAT	
k-l	1	MOSAICO	PLETINA UNION CONNECTOR	302.31	-	-	-	-	
m	1	MOSAICO	BASE 100X50 PARA 1 ALMOHADA BASE 100X50 FOR 1 SEAT	302.89.L.V	041 MALAQUITA	-	-	-	
m	1	MOSAICO	ALMOHADA 100X50 SEAT 100X50	302.15.L.V	-	6236	6	123	
m	1	MOSAICO	RESPALDO ANGULO CORNER BACK	302.1A.G	-	6236	6	123	
m.1	1	RIFT	COJIN 30X30 VERDE CUSHION 30X30 GREEN	324.22.DD.C1	-	-	-	-	

ID	UNI.	MOD.	DESCRIPCIÓN / DESCRIPTION	REF.	ACABADO FINISHES	TELAS / FABRICS	SERIES	MUESTRARIO SAMPLE	
						ALMOHADA CUSHION	BASE		
a	1	REW	BANCADA 120 L FONDO 57 L-SIZE DEEP BENCH 120	292.12.NFK	002 NATURAL	PLANUM 411	8	FEBRIK KVADRAT	
a	1	REW	BRAZO L FONDO 57 DCHO L-SIZE SHALLOW RIGHT ARM	292.133.FK.D	-	PLANUM 411	8	FEBRIK KVADRAT	
b	1	REW	BANCAD 240 L FONDO 57 L-SIZE DEEP BENCH 240	292.12.21FK	002 NATURAL	PLANUM 411	8	FEBRIK KVADRAT	
b	1	REW	BRAZO L FONDO 57 IZDO L-SIZE SHALLOW LEFT ARM	292.133.FK.I	-	PLANUM 411	8	FEBRIK KVADRAT	
c	1	REW	KIT ELECTRICO MIXTO 1 BASE ENCHUFE + 1 USB MIXED ELECTRIC SET 1 PLUG BASE + 1 USB	292.2H.MIX	-	-	-	-	
c	1	REW	BANCADA 180 L FONDO 72 L-SIZE DEEP BENCH 180	292.12.UHK	002 NATURAL	ATLANTIC 63033	2	112	
c	1	REW	BRAZO L FONDO 57 IZDO L-SIZE SHALLOW LEFT ARM	292.133.FK.I	-	ATLANTIC 63033	2	112	
c	1	REW	BRAZO L FONDO 57 DCHO L-SIZE SHALLOW RIGHT ARM	292.133.FK.D	-	ATLANTIC 63033	2	112	
d	1	REW	BANCADA 180 XL FONDO 57 XL-SIZE SHALLOW BENCH 180	292.12.UFM	002 NATURAL	PLANUM 411	8	FEBRIK KVADRAT	
d	1	REW	BRAZO XL FONDO 57 IZDO XL-SIZE SHALLOW LEFT ARM	292.133.FM.I	-	PLANUM 411	8	FEBRIK KVADRAT	
d	1	REW	BRAZO XL FONDO 57 DCHO XL-SIZE SHALLOW RIGHT ARM	292.133.FM.D	-	PLANUM 411	8	FEBRIK KVADRAT	
d.1	1	MANDARINA	COJIN D40X14 FRUNCIDO WINKLED CUSHION D40X14	267.24.E.0	-	61103	3	108	
d.2	1	BANG!	COJIN 40X40 LIMON-TABACO CUSHION 40X40 LEMON-EARTH	299.22.EE.2	-	CODA 410 / STEP 61103	-	KVADRAT / 108	



Konoha pag 220 - 221

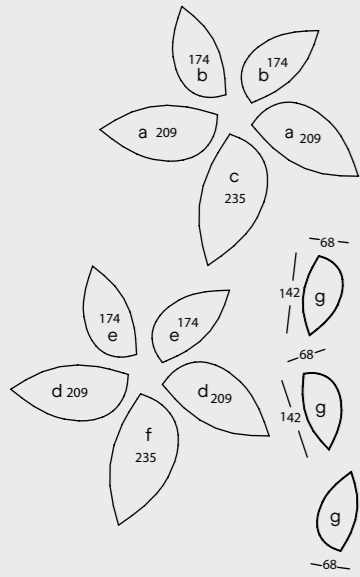

e	1	REW	BANCADA 240 XL FONDO 57 XL-SIZE SHALLOW BENCH 240	292.12.Z1FM	002 NATURAL	2776	3	110
e	1	REW	BRAZO XL FONDO 57 IZDO XL-SIZE SHALLOW LEFT ARM	292.133.FM.I	-	2776	3	110
e	1	REW	BRAZO XL FONDO 57 DCHO XL-SIZE SHALLOW RIGHT ARM	292.133.FM.D	-	2776	3	110

ID	UNI.	MOD.	DESCRIPCIÓN / DESCRIPTION	REF.	ACABADO FINISHES	TELAS / FABRICS		SERIES	MUESTRARIO SAMPLE
						ALMOHADA CUSHION	BASE		
a	2	KONoha	BANCO 209X101 BENCH 209X101	259.10.WLE	-	FIORD 251		8	KVADRAT
b	2	KONoha	BANCO 174X84 BENCH 174X84	259.10.TJE	-	FIORD 251		8	KVADRAT
c	1	KONoha	BANCO 235X113 BENCH 235X113	259.10.ZME	-	FIORD 251		8	KVADRAT
d	2	KONoha	BANCO 209X101 BENCH 209X101	259.10.WLE	-	FIORD 991		8	KVADRAT
e	2	KONoha	BANCO 174X84 BENCH 174X84	259.10.TJE	-	FIORD 991		8	KVADRAT
f	1	KONoha	BANCO 235X113 BENCH 235X113	259.10.ZME	-	FIORD 991		8	KVADRAT
g	3	KONoha	BANCO 142X68 BENCH 142X68	259.10.QGE	-	FIORD 201		8	KVADRAT

Nudo pag 222 - 223

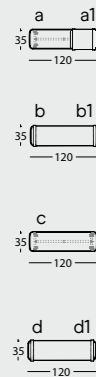

ID	UNI.	MOD.	DESCRIPCIÓN / DESCRIPTION	REF.	ACABADO FINISHES	TELAS / FABRICS		SERIES	MUESTRARIO SAMPLE
						ALMOHADA CUSHION	BASE		
a	1	NUDO	BANCO 120 BENCH 120	280.10.N	002 NATURAL	-	-	-	-
a.1	1	NUDO	COJIN DOBLE 34X47 DOUBLE CUSHION 34X47	280.22.DE	-	2779 / STEP 64159		3	110 / 108
b	1	NUDO	BANCO 120 BENCH 120	280.10.N	052 KLEIN	-	-	-	-
b.1	1	NUDO	COJIN DOBLE 34X118 DOUBLE CUSHION 34X118	280.22.DM	-	2773 / ATLANTIC 65074		3 / 2	110 / 112
c	1	NUDO	BANCO 120 BENCH 120	280.10.N	003 NOGAL	-	-	-	-
d	1	NUDO	BANCO 120 BENCH 120	280.10.N	108 NEGRO	-	-	-	-
d.1	1	NUDO	COJIN DOBLE 34X118 DOUBLE CUSHION 34X118	280.22.DM	-	2783 / STEP 62057		3	110 / 108

Menú pag 224 - 225

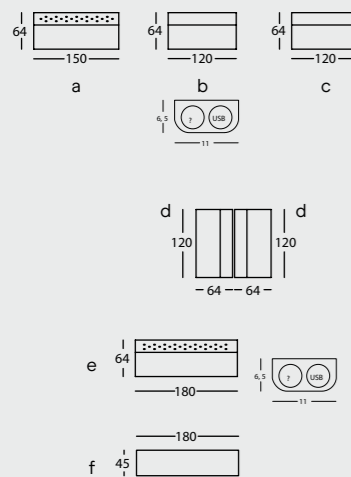

ID	UNI.	MOD.	DESCRIPCIÓN / DESCRIPTION	REF.	ACABADO FINISHES	TELAS / FABRICS		SERIES	MUESTRARIO SAMPLE
						ALMOHADA CUSHION	BASE		
a	1	MENU	MOD 150 PATA MADERA + BOTONES MOD 150 WOODEN FEET + BUTTONS	257.121.R.6	006 ANTRACITA	9002 CARBON		3	SILVERTEX MET
b	1	MENU	MOD 120 PATA METAL MOD 120 METAL FEET	257.121.N.7	001 NEGRO	FACET 2 1000		4	107.2
b	1	MENU	KIT ELECTRICO MIXTO 1 BASE ENCHUFE + 1 USB MIXED ELECTRIC SET 1 PLUG BASE + 1 USB	257.2H.MIX	-	-		-	-
c	1	MENU	MOD 120 ZOCALO MADERA MOD 120 WOODEN BASE	257.121.N.Z6	002 NATURAL	005 CHALK		4	CADET
d	2	MENU	MOD 120 ZOCALO TAPIZADO MOD 120 UPHOLSTERED BASE	257.121.N.ZT	-	FACET 2 1000		4	107.2
e	1	MENU	MOD 180 PATA MADERA + BOTONES MOD 180 WOODEN FEET + BUTTONS	257.121.U.6	002 NATURAL	STEP MELANGE 68118		3	108
e	1	MENU	KIT ELECTRICO MIXTO 1 BASE ENCHUFE + 1 USB MIXED ELECTRIC SET 1 PLUG BASE + 1 USB	257.2H.MIX	-	-		-	-
f	1	MENU	BANCO 180 PATA MADERA SIN RESP. BENCH 180 WOODEN FEET (NO BACK)	257.151.U.6	002 NATURAL	STEP 68118		3	108

Pufs Taburetes

Poufs Stools

Meeting Point pag 228 - 229

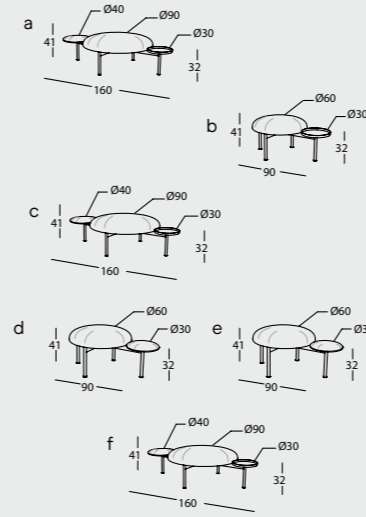

ID	UNI.	MOD.	DESCRIPCIÓN / DESCRIPTION	REF.	ACABADO FINISHES	TELAS / FABRICS		SERIES	MUESTRARIO SAMPLE
						ALMOHADA CUSHION	BASE		
a	1	MEETING POINT	PUF 160x90 MESA D30 METAL POUF 160x90 TABLE D30 METAL	333.15.S.7	002 NATURAL / 151 NEGRO	STEELCUT TRIO 3 205		8	KVADRAT
b	1	MEETING POINT	PUF 90x60 MESA D30 METAL POUF 90x60 TABLE D30 METAL	333.15.K.7	151 NEGRO	STEP 62057		3	108
c	1	MEETING POINT	PUF 160x90 MESA D30 METAL POUF 160x90 TABLE D30 METAL	333.15.S.7	049 GRIS SEDA / 155 ORO	PLECTO 0244		9	FEBRIK KVADRAT
d	1	MEETING POINT	PUF 90x60 MESA D30 FRESNO POUF 90x60 TABLE D30 ASH	333.15.KG	151 NEGRO	6257		6	126
e	3	MEETING POINT	PUF 90x60 MESA D30 FRESNO POUF 90x60 TABLE D30 ASH	333.15.KG	151 NEGRO	6252		6	126
f	1	MEETING POINT	PUF 160x90 MESA D30 METAL POUF 160x90 TABLE D30 METAL	333.15.S.7	108 NEGRO / 151 NEGRO	MOSAIC 2 182		9	FEBRIK KVADRAT

Meeting Point pag 230 - 231

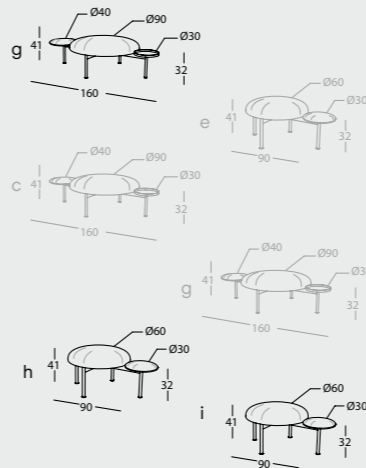

ID	UNI.	MOD.	DESCRIPCIÓN / DESCRIPTION	REF.	ACABADO FINISHES	TELAS / FABRICS		SERIES	MUESTRARIO SAMPLE
						ALMOHADA CUSHION	BASE		
g	2	MEETING POINT	PUF 160x90 MESA D30 METAL POUF 160x90 TABLE D30 METAL	333.15.S.7	108 NEGRO / 151 NEGRO	ATLANTIC 62049		2	112
h	1	MEETING POINT	PUF 90x60 MESA D30 FRESNO POUF 90x60 TABLE D30 ASH	333.15.KG	108 NEGRO	PLECTO 0564		9	FEBRIK KVADRAT
i	1	MEETING POINT	PUF 90x60 MESA D30 FRESNO POUF 90x60 TABLE D30 ASH	333.15.KG	049 GRIS SEDA	6257		6	126

Meeting Point pag 232 - 233

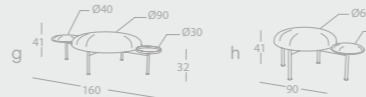

Elephant pag 234 - 235

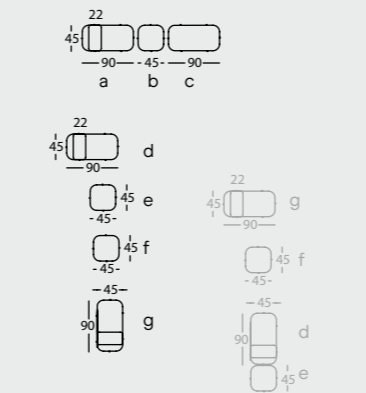

ID	UNI.	MOD.	DESCRIPCIÓN / DESCRIPTION	REF.	ACABADO FINISHES	TELAS / FABRICS		SERIES	MUESTRARIO SAMPLE
						ALMOHADA CUSHION	BASE		
a	1	ELEPHANT	PUF 90X45 CON BANDEJA POUF 90X45 WITH TRAY	289.15.KE.K	087 COBRE / 002 NATURAL	REMIX 2 982		6	KVADRAT
b	1	ELEPHANT	PUF 45X45 POUF 45X45	289.15.EE	087 COBRE	FACET 2 56		4	107.2
c	1	ELEPHANT	PUF 90X45 CON BANDEJA POUF 90X45 WITH TRAY	289.15.KE.K	087 COBRE	FACET 2 144		4	107.2
d	1	ELEPHANT	PUF 90X45 CON BANDEJA POUF 90X45 WITH TRAY	289.15.KE.K	086 GRAFITO 003 NOGAL	PLANUM 351		8	FEBRIK KVADRAT
e	1	ELEPHANT	PUF 45X45 POUF 45X45	289.15.EE	086 GRAFITO	2602		3	72
f	1	ELEPHANT	PUF 45X45 POUF 45X45	289.15.EE	086 GRAFITO	STEP MELANGE 68119		3	108
g	1	ELEPHANT	PUF 90X45 CON BANDEJA POUF 90X45 WITH TRAY	289.15.KE.K	086 GRAFITO / 002 NATURAL	FACET 2 24		4	107.2











# Accesorios Accessories

Mind the gap pag 302 - 305

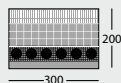

a

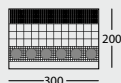

b

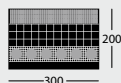

c

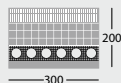

d

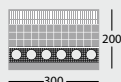

e

ID	UNI.	MOD.	DESCRIPCIÓN / DESCRIPTION	REF.	ACABADO FINISHES	TELAS / FABRICS		SERIES	MUESTRARIO SAMPLE
						ALMOHADA CUSHION	BASE		
a	1	MIND THE GAP	ALFOMBRA 200X300 PIEDRA CARPET 200X300 STONE	334.6.WZ7.S	-	-	-	-	-
b	1	MIND THE GAP	ALFOMBRA 200X300 CREMA CARPET 200X300 CREAMY	334.6.WZ7.C	-	-	-	-	-
c	1	MIND THE GAP	ALFOMBRA 200X300 NEGRO CARPET 200X300 BLACK	334.6.WZ7.B	-	-	-	-	-
d	1	MIND THE GAP	ALFOMBRA 200X300 PUNTO ROJO CARPET 200X300 RED DOTS	334.6.WZ7.R	-	-	-	-	-
e	1	MIND THE GAP	ALFOMBRA 200X300 PUNTO AMARILLO CARPET 200X300 YELLOW DOTS	334.6.WZ7.Y	-	-	-	-	-

Float pag 306



a-b-c

ID	UNI.	MOD.	DESCRIPCIÓN / DESCRIPTION	REF.	ACABADO FINISHES	TELAS / FABRICS		SERIES	MUESTRARIO SAMPLE
						ALMOHADA CUSHION	BASE		
a	1	FLOAT	PERCHERO PARED WALL HOOK	281.38	052 KLEIN	-	-	-	-
b	2	FLOAT	PERCHERO PARED WALL HOOK	281.38	002 NATURAL	-	-	-	-
c	1	FLOAT	PERCHERO PARED WALL HOOK	281.38	108 NEGRO	-	-	-	-

## CALIDAD

La satisfacción de nuestros clientes y la calidad de nuestros productos es un elemento central en la política de Sancal, por ello la empresa apuesta por la Mejora Continua a través de un riguroso Sistema de Gestión de la Calidad que se rige por la normativa ISO 9001. Además, la calidad de nuestros productos está garantizada por el saber hacer de nuestro personal y por la supervisión directa de una fabricación made in Spain.

## ENSAYOS

Sancal ensaya sus productos en los laboratorios de CETEM y/o de AIDIMA según las normativas UNE (Española) y UNE EN (Europea) para usos en espacios públicos.

El Símbolo Calidad Controlada certifica a aquellos muebles que han superado diferentes ensayos y reconoce que son adecuados para el uso al que están destinados.

Los test específicos a los que son sometidos nuestros productos comprueban la Durabilidad; la Estabilidad; la Resistencia estática; la Resistencia a impactos y caídas y la Seguridad de los mismos.

Según el tipo de productos las normas que aplicamos son:

<b>ASIENTOS</b>	
Sofás, bancadas, sillas y butacas	
<b>Uso domestico</b>	
Norma ensayo	UNE EN 1728:2013
Norma especificación	UNE EN 12520:2016
<b>Mobiliario público</b>	
Norma ensayo	UNE EN 1728:2013
Norma especificación	UNE EN 16139:2013 L2
<b>MESAS</b>	
Norma ensayo	UNE EN 1730:2013
Norma especificación	UNE EN 15372:2017 N2 - N3

## ECOLOGÍA

La conservación del medio ambiente nos preocupa y ha preocupado desde la fundación de la empresa. El consumo sostenible y el reciclaje son nuestras máximas. Asimismo el tratamiento que damos a nuestros residuos cumple con las normativas europeas correspondientes y empleamos madera proveniente de bosques renovables. La Región de Murcia ha concedido a Sancal el distintivo de Empresa Comprometida con el Desarrollo Sostenible.

A partir de 2010 esta filosofía se consolida con la ISO 14001 a través de un riguroso Sistema de Gestión Medioambiental.

## GARANTÍAS

Sancal garantiza todos sus productos hasta 2 años y las estructuras internas de sus sofás y módulos hasta 10 años, a partir de la fecha de compra indicada en la factura.

Estas garantías son válidas exclusivamente cuando el producto es empleado en aquellas actividades para las que fue concebido. La garantía queda revocada automáticamente en caso de un uso inapropiado del producto o de la manipulación de los componentes del mismo.

## QUALITY

The main aim of Sancal's policy is to achieve customer satisfaction and quality products, thus the firm implements Ongoing Improvements through a thorough System of Quality Management ruled by the ISO 9001 standard. Moreover, quality is guaranteed by our personnel's know-how and the direct monitoring of our manufactured products, which bear the made in Spain guarantee.

## TESTS

Sancal tests its products in the CETEM and/or AIDIMA laboratories depending on the UNE (Spanish) and UNE EN (European) standard for use in public spaces.

The Quality Controlled Symbol certifies all pieces of furniture that have passed different tests and recognises that they are suitable for the use for which they were designed.

The specific tests to which our products are subject to check: durability; stability; static resistance; resistance to impacts and its security.

Depending on the type of products, the standards applied are:

<b>SEATS</b>	
Sofas, benches, and small armchairs	
<b>Domestic use</b>	
Test rule	UNE EN 1728:2013
Specification rule	UNE EN 12520:2016
<b>Public use</b>	
Test rule	UNE EN 1728:2013
Specification rule	UNE EN 16139:2012 L2
<b>TABLES</b>	
Standard rule	UNE EN 1730:2013
Specification rule	UNE EN 15372:2017 N2 - N3

## ECOLOGY

We are concerned with environmental conservation, and have been since the company was established. Sustainable consumption is our motto and recycling is a reality for all Sancal personnel. The treatment we give our resources complies with the relevant European regulations, and the wood used in our products comes from renewable forests. The Region of Murcia has conferred distinction on Sancal as a Company Committed to Sustained Development.

From 2010 this philosophy was consolidated with the ISO 14001 through a rigorous Environmental Management System.

## GUARANTEES

Sancal guarantees all its products for up to 2 years and the internal structures of its sofas and units for up to 10 years from the purchase date stated on the invoice.

These guarantees are only valid when the product is used in those applications for which it was made. The guarantee will be automatically revoked in the event of inappropriate product use and is subject to Sancal's general terms and conditions.







REF. 19026\_black\_book

**Art direction & styling** Elena Castaño-López, Esther Castaño-López, Carolina Mico Navarro y Juan Ibáñez Lax.

**Photography** David Frutos - Marcelo Martínez - Rafa Molina - Manolo Santa

**Coordination** Esther Castaño-López

**Graphic project** Juan Ibáñez Lax y Sonia Marco

**Thanks To:**

Nama's lingerie department (Studio AKSL arhitekti - Photo Janez Marolt)

Casa MAC

Vivienda En La Moraleja\_CSO Arquitectos

Casa Elekna

Concha & Santiago

Jaime Sepulcre - Casa Matola

Crystalzoo

Pastor & González Arquitectos

Jessica Bataille

José Ángel García & Miriam Hernández

Antonio Abellán

Paco Sola

David & Camila

Blancafort + Reus

Minuca Carreño

Bea Romero

Eduardo Piqueras

Luis Soriano Hernández

Manodesanta by Marialsoy

Mackinaw

Luneda

LZF

QUARTA

SANCAL DISEÑO, S.L.

Pol. Ind. La Herrada C/Príncipe de Asturias, 18

30510 Yecla (Murcia) Spain

Tel Esp. +34 968 75 15 03

Tel. Eng. +34 968 71 90 62

Tel. Fra. +34 968 71 90 61

Fax +34 968 79 40 62

e-mail [web@sancal.com](mailto:web@sancal.com)

[www.sancal.com](http://www.sancal.com)

Print Gráficas Alcoy

Copyright © Sancal Diseño S.L. 2020





